

SPECIFICATIONS SUBJECT TO CHANGE WITHOUT NOTICE
 DIMENSIONS ARE FOR REFERENCE ONLY
 DIMENSIONS ARE IN mm [INCHES]

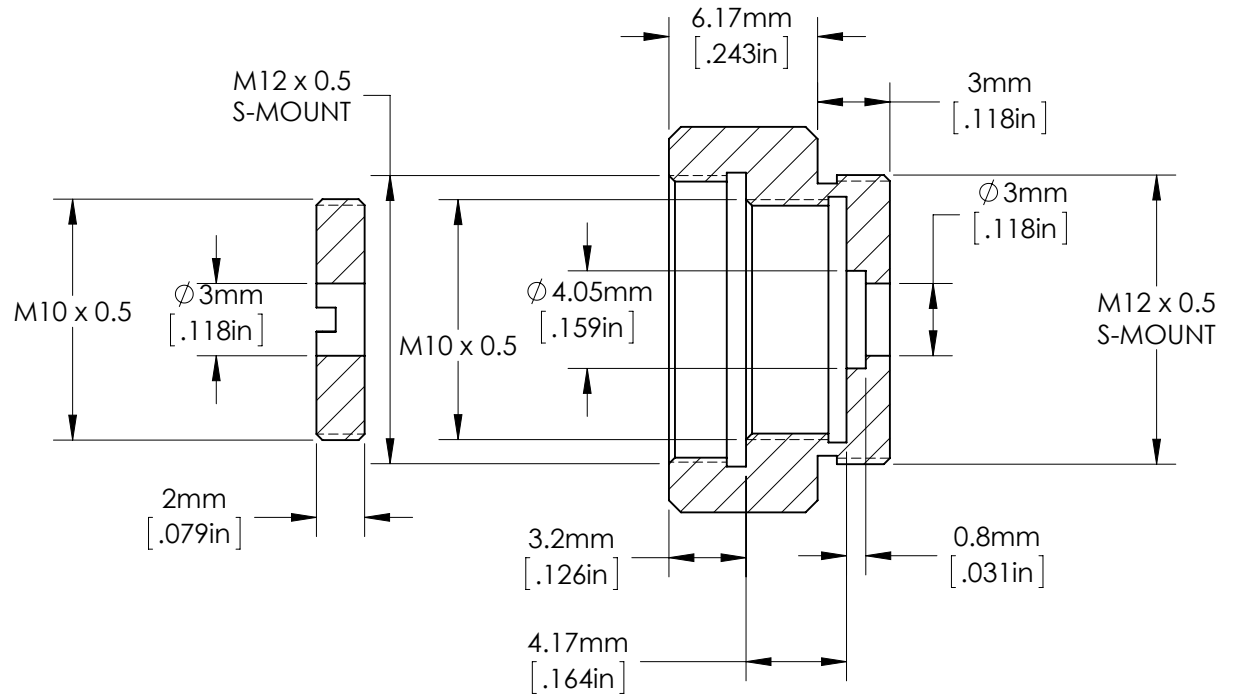

SECTION A-A

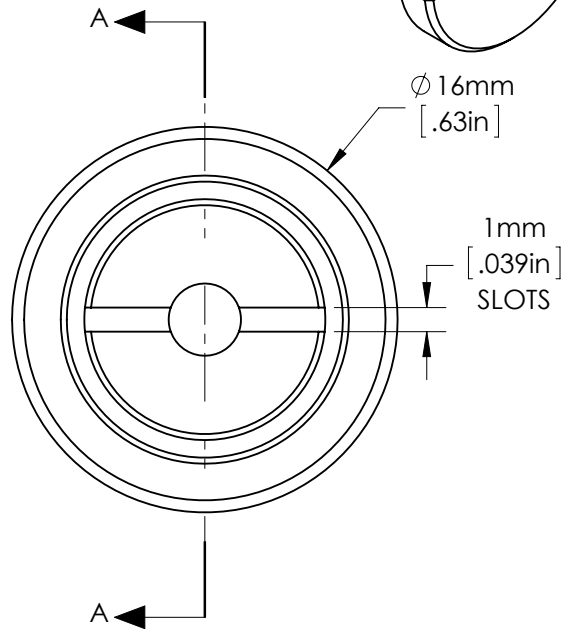
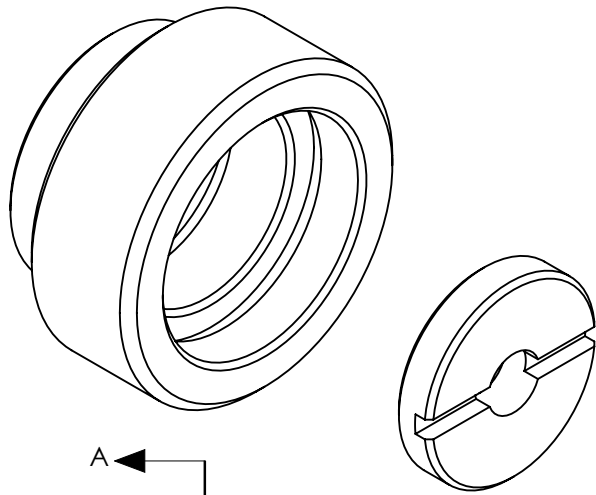

TITLE	S-Mount Thin Lens Mount (4mm Diameter)				
DWG NO	63939	MATERIAL	BLACK ANODIZED ALUMINUM	SHEET 1 OF 1	REV 000

Enable 3D View