

NOTES:

1. ELEMENT A: 32724
2. ELEMENT B: 32724

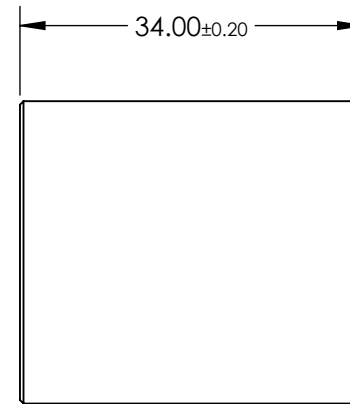
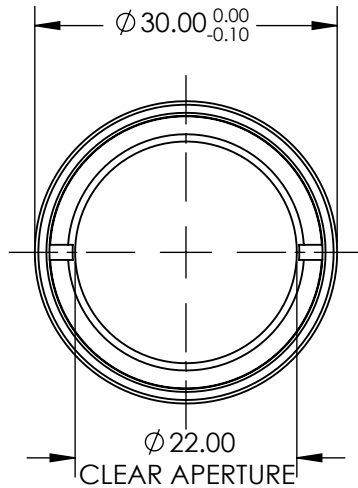
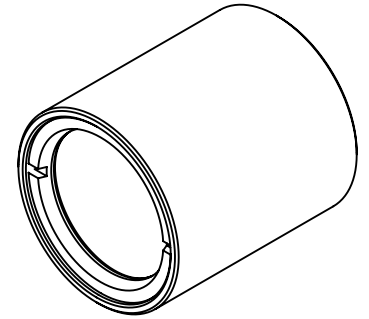

SPECIFICATIONS SUBJECT TO CHANGE WITHOUT NOTICE
DIMENSIONS ARE FOR REFERENCE ONLY

**FOR INFORMATION ONLY:
DO NOT MANUFACTURE
PARTS TO THIS DRAWING**

EO® Edmund Optics®

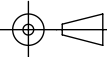
THIRD ANGLE PROJECTION 		TITLE	1:1 WITH 60mm AND 60mm EFL ACHROMATS, 30mm ACHROMATIC PAIR	
ALL DIMS IN	mm	DWG NO	55276	SHEET 1 OF 1