

NOTES:

1. SUBSTRATE MATERIAL:
FLOAT GLASS
2. COATING (APPLW ACROSS CLEAR APERTURE):
S1: BARE ALUMINUM
S2: NONE
3. BLAZE ANGLE: 8° 37'
NOMINAL BLAZE WAVELENGTH: 250nm
EFFICIENCY: 60-80% @ BLAZE WAVELENGTH

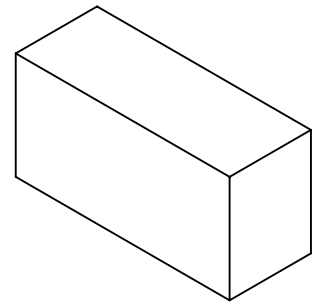

4. EDGES GROUND
5. RoHS COMPLIANT

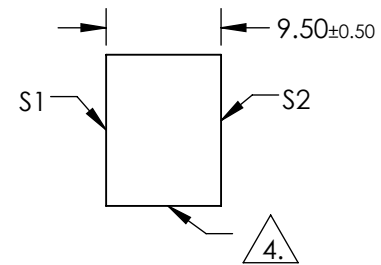
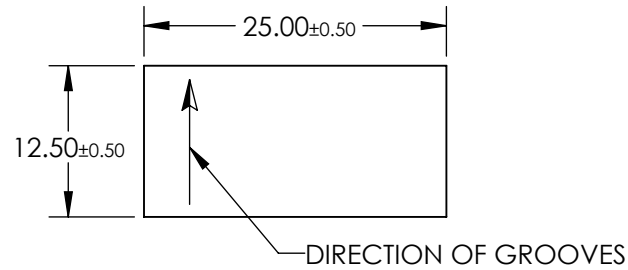

SPECIFICATIONS SUBJECT TO CHANGE WITHOUT NOTICE
DIMENSIONS ARE FOR REFERENCE ONLY

**FOR INFORMATION ONLY:
DO NOT MANUFACTURE
PARTS TO THIS DRAWING**



	S1	S2	THIRD ANGLE PROJECTION		TITLE	GRATING DIFF 1200GR 250nm 12.5 x 25	
SHAPE	PLANO	PLANO	ALL DIMS IN	mm	DWG NO	41039	SHEET 1 OF 1
CLEAR APERTURE	11.25 x 22.5	11.25 x 22.5					