

NOTES:

1. SUBSTRATE:  
GRADE A FINE ANNEALED  
SCHOTT: N-BK7 517/642
2. ROHS COMPLIANT
3. CENTERING TOLERANCE (AT 587.6nm):  
BEAM DEVIATION (HALF ANGLE): <1 ARCMIN
4. COATING (APPLY ACROSS COATING APERTURE)  
S1 & S2: NIR II  
R(ABS) ≤ 1.5% FROM 750-800nm @ 0° AOI  
R(ABS) ≤ 1.0% FROM 800-1550nm @ 0° AOI  
R(AVG) ≤ 0.7% FROM 750-1550nm @ 0° AOI

5. FINE GRIND SURFACE

6. POWER, IRREGULARITY, AND SURFACE QUALITY SPECIFICATIONS APPLY ACROSS CLEAR APERTURE

7. FOCAL LENGTH (EFL): 100.00mm ±1%  
BACK FOCAL LENGTH (BFL): 98.95mm

8. PROTECTIVE BEVEL AS NEEDED

9. DESIGN WAVELENGTH: 587.6nm

10. BLACKENED SURFACE

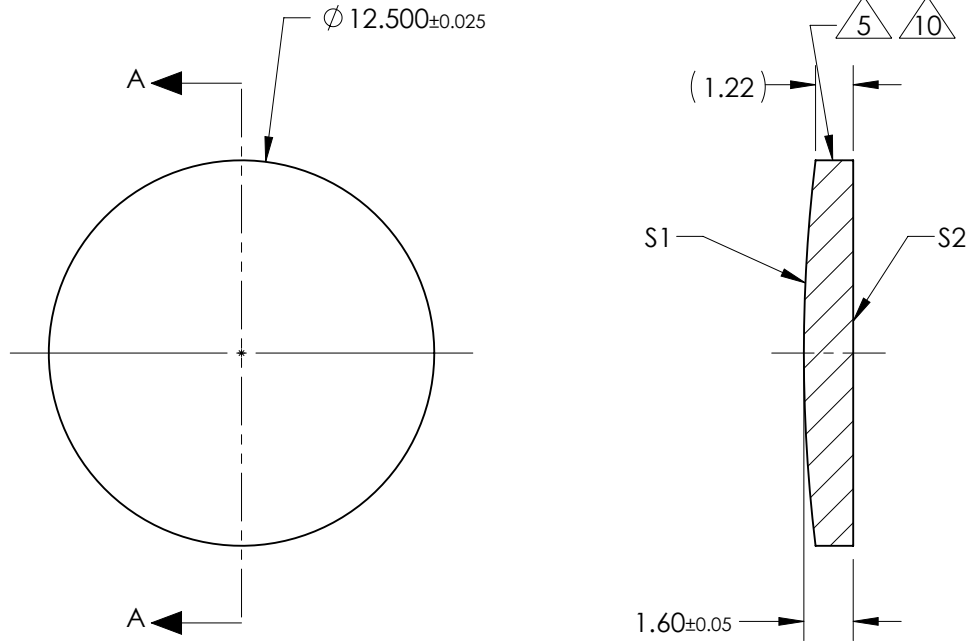

SECTION A-A

**FOR INFORMATION ONLY:  
DO NOT MANUFACTURE  
PARTS TO THIS DRAWING**

	S1	S2
SHAPE	CONVEX	PLANO
RADIUS	51.68	INFINITY
SURFACE QUALITY	40 - 20	40 - 20
MIN CLEAR APERTURE	$\phi 11.50$	$\phi 11.50$
MIN COATING APERTURE	$\phi 11.50$	$\phi 11.50$
POWER AT 632.8nm	3.00 RINGS	3.00 RINGS
IRREGULARITY AT 632.8nm	0.50 RINGS	0.50 RINGS

SPECIFICATIONS SUBJECT TO CHANGE WITHOUT NOTICE  
DIMENSIONS ARE FOR REFERENCE ONLY

**EO**® Edmund Optics®

THIRD ANGLE PROJECTION		TITLE	12.5mm Dia. x 100.0mm FL, NIR II, Inked, Plano-Convex Lens
ALL DIMS IN	mm	DWG NO	38408INK
			SHEET 1 OF 1