

NOTES:

1. SUBSTRATE:
N-BK7
2. REFLECTION: 0.5%
DAMAGE THRESHOLD,
PULSED: Visible: 300 mJ/cm² @ 10ns, 1064nm: 500 mJ/cm² @ 10ns
CW: 500 W/cm²
3. BEAM DEVIATION: 1 arcmin
4. RETARDANCE: $\lambda/2 \pm \lambda/100$
5. DESIGN WAVELENGTH: 735 - 985nm
6. CONSTRUCTION: Birefringent Polymer Stack
7. OPERATING TEMPERATURE (°C): -20 to +50
8. ROHS: COMPLIANT
9. PRECISION POLYMER WAVEPLATES (RETARDERS) ARE MOUNTED IN A METAL RING WITH THE FAST AXIS CLEARLY MARKED

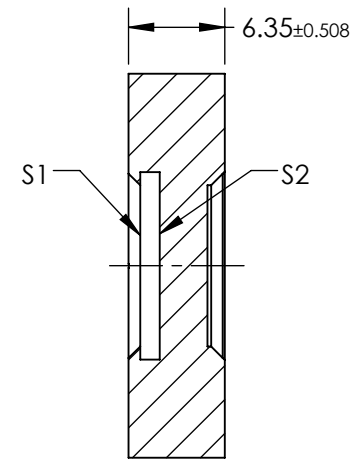
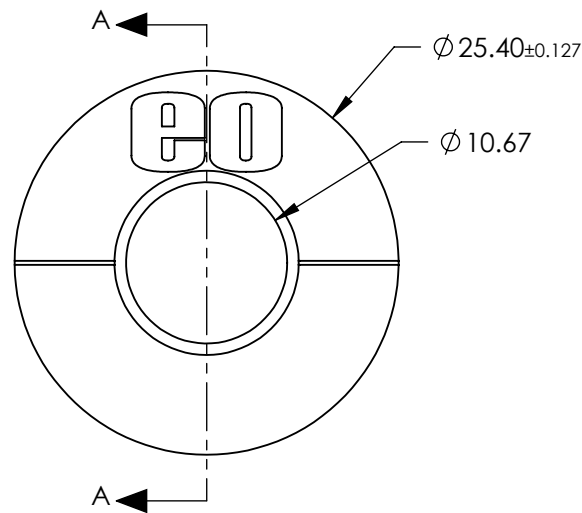
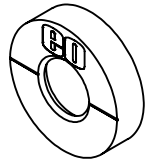

SECTION A-A

**FOR INFORMATION ONLY:
DO NOT MANUFACTURE
PARTS TO THIS DRAWING**

SPECIFICATIONS SUBJECT TO CHANGE WITHOUT NOTICE
DIMENSIONS ARE FOR REFERENCE ONLY

EO® Edmund Optics®

	S1	S2	THIRD ANGLE PROJECTION		TITLE	$\lambda/2$ 735-985nm, Polymer Achromatic Retarder	
CLEAR APERTURE	$\phi 10.16$	$\phi 10.16$	ALL DIMS IN	mm	DWG NO	49229	SHEET 1 OF 1
SURFACE QUALITY	40-20	40-20					