

NOTES:

1. SUBSTRATE:
CORNING: FUSED SILICA 458/678
2. ROHS COMPLIANT
3. CENTERING TOLERANCE (AT 587.6nm):
BEAM DEVIATION (HALF ANGLE): <1 ARCMIN
4. COATING (APPLY ACROSS COATING APERTURE)
S1 & S2: 355nm Laser AR Coating
R(ABS) < 0.25% @ 355nm @ 0° AOI

DAMAGE THRESHOLD
PULSED: 7.5J/cm² @ 20ns, 20Hz @ 355nm
5. FINE GRIND SURFACE
6. POWER, IRREGULARITY, AND SURFACE QUALITY SPECIFICATIONS APPLY ACROSS CLEAR APERTURE
7. FOCAL LENGTH (EFL): 300.00mm ±1%
BACK FOCAL LENGTH (BFL): 297.38mm
8. PROTECTIVE BEVEL AS NEEDED
9. DESIGN WAVELENGTH: 355nm

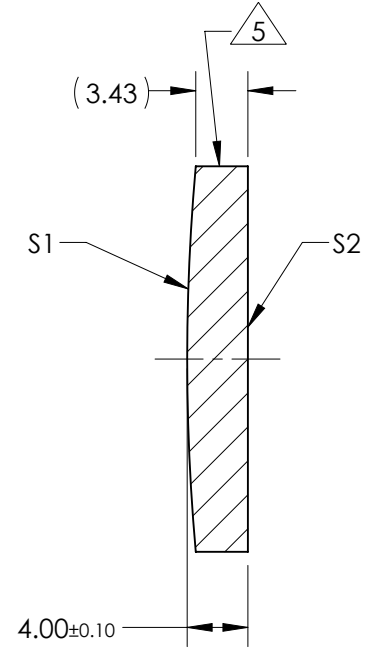
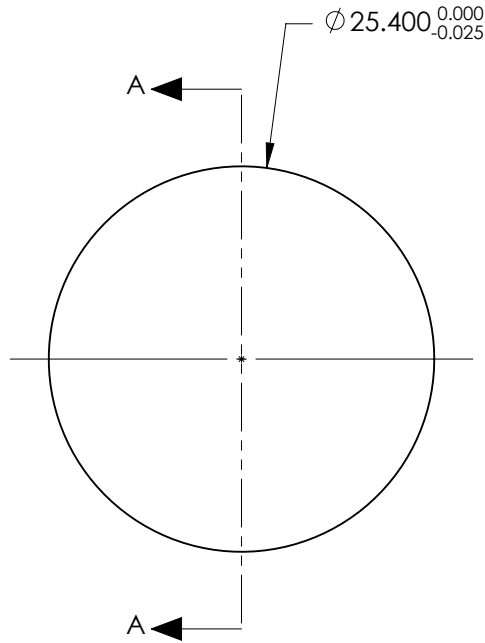

SECTION A-A

**FOR INFORMATION ONLY:
DO NOT MANUFACTURE
PARTS TO THIS DRAWING**

	S1	S2
SHAPE	CONVEX	PLANO
RADIUS	142.83	INFINITY
SURFACE QUALITY	10 - 5	10 - 5
MIN CLEAR APERTURE	∅ 21.59	∅ 21.59
MIN COATING APERTURE	∅ 21.59	∅ 21.59
POWER AT 632.8nm	2.0 RINGS	2.0 RINGS
IRREGULARITY AT 632.8nm	0.2 RINGS	0.2 RINGS

SPECIFICATIONS SUBJECT TO CHANGE WITHOUT NOTICE
DIMENSIONS ARE FOR REFERENCE ONLY

EO® Edmund Optics®

THIRD ANGLE PROJECTION		TITLE	25.4mm Dia x 300mm EFL, 355nm Coated, Laser Grade PCX Lens	
ALL DIMS IN	mm	DWG NO	38678	SHEET 1 OF 1