

[See all 239 Products in Family](#)

TECHSPEC® 100.0mm Dia. x 200.0mm FL, MgF₂ Coated, Plano-Convex Lens



Stock **#17-900** [CONTACT US](#)

[Other Coating Options](#)

1 **A\$552^{.00}**

ADD TO CART

Volume Pricing	
Qty 1-5	A\$552.00 each
Qty 6-24	A\$496.00 each
Qty 25-49	A\$441.60 each
Need More?	Request Quote

Product Downloads

General

Plano-Convex Lens **Type:**

Physical & Mechanical Properties

100.00 +0.0/-0.50 **Diameter (mm):**

<3	Centering (arcmin):
14.00 ±0.10	Center Thickness CT (mm):
1.10	Edge Thickness ET (mm):
90.00	Clear Aperture CA (mm):
Protective as needed	Bevel:

Optical Properties

200.00 @587.6mm	Effective Focal Length EFL (mm):
190.77	Back Focal Length BFL (mm):
MgF ₂ (400-700nm)	Coating:
R _{avg} ≤1.75% @ 400 - 700nm	Coating Specification:
N-BK7	Substrate: <input type="checkbox"/>
60-40	Surface Quality:
3.0λ	Power (P-V) @ 632.8nm:
λ/2	Irregularity (P-V) @ 632.8nm:
±1	Focal Length Tolerance (%):
103.36	Radius R ₁ (mm):
2	f#:
0.25	Numerical Aperture NA:
400 - 700	Wavelength Range (nm):
10 J/cm ² @ 532nm, 10ns	Damage Threshold, By Design: <input type="checkbox"/>

Regulatory Compliance

Compliant	RoHS 2015:
View	Certificate of Conformance:
Compliant	Reach 235:

Need different specs or modifications?

Edmund Optics offers comprehensive custom manufacturing services for optical and imaging components tailored to your specific application requirements. Whether in the prototyping phase or preparing for full-scale production, we provide flexible solutions to meet your needs. Our experienced engineers are here to assist—from concept to completion.

Our capabilities include:

- Custom dimensions, materials, coatings, and more
- High-precision surface quality and flatness
- Tight tolerances and complex geometries
- Scalable production—from prototype to volume

Learn more about our [custom manufacturing capabilities](#) or submit an inquiry [here](#).

Product Details

- AR Coated to Provide <1.75% Reflectance per Surface for 400 - 700nm
- Designed for 0° Angle of Incidence
- Various PCX Coating Options: [Uncoated](#), [VIS 0°](#), [VIS-NIR](#), [NIR I](#), [NIR II](#), [VIS-EXT](#), and [YAG-BBAR](#)
- Also Available [Pre-Mounted in Engraved C-Mount Housings](#)

TECHSPEC® MgF₂ Coated Plano-Convex (PCX) Lenses have a positive focal length, making them ideal for collecting and focusing light in imaging applications. They are also useful in a variety of applications involving emitters, detectors, lasers, and fiber optics. TECHSPEC® MgF₂ Coated Plano-Convex (PCX) Lenses are available in a wide variety of diameters and focal lengths. Identical designs of these PCX lenses are also offered [uncoated](#) or with broadband anti-reflective (BBAR) coatings, which include [VIS 0°](#), [VIS-NIR](#), [NIR I](#), [NIR II](#), [VIS-EXT](#), and [YAG-BBAR](#).

Technical Information

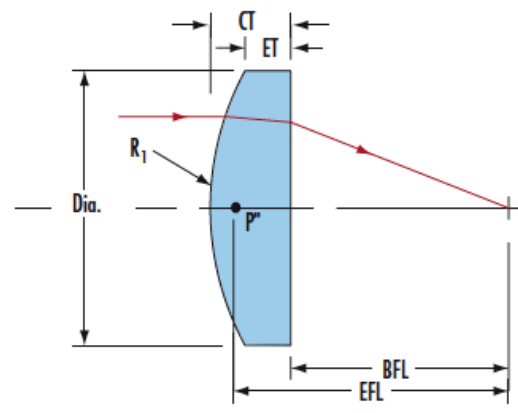
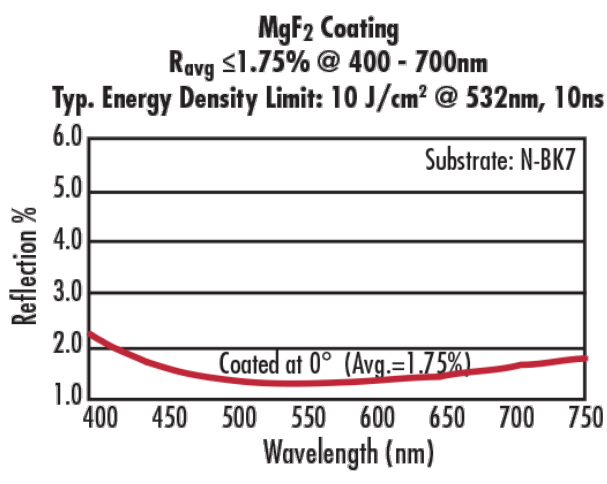

N-BK7	
<p>Uncoated N-BK7 Typical Transmission</p> <p>T (%)</p> <p>Wavelength (nm)</p>	<p>Typical transmission of a 3mm thick, uncoated N-BK7 window across the UV - NIR spectra.</p> <p>Click Here to Download Data</p>
<p>N-BK7 with MgF₂ Coating Typical Transmission</p> <p>T (%)</p> <p>Wavelength (nm)</p>	<p>Typical transmission of a 3mm thick N-BK7 window with MgF₂ (400-700nm) coating at 0° AOI.</p> <p>The blue shaded region indicates the coating design wavelength range, with the following specification:</p> <p>$R_{avg} \leq 1.75\% @ 400 - 700\text{nm}$ (N-BK7)</p> <p>Data outside this range is not guaranteed and is for reference only.</p> <p>Click Here to Download Data</p>
<p>N-BK7 with VIS-EXT Coating Typical Transmission</p> <p>T (%)</p> <p>Wavelength (nm)</p>	<p>Typical transmission of a 3mm thick N-BK7 window with VIS-EXT (350-700nm) coating at 0° AOI.</p> <p>The blue shaded region indicates the coating design wavelength range, with the following specification:</p> <p>$R_{avg} \leq 0.5\% @ 350 - 700\text{nm}$</p> <p>Data outside this range is not guaranteed and is for reference only.</p> <p>Click Here to Download Data</p>

N-BK7 with VIS-NIR Coating Typical Transmission

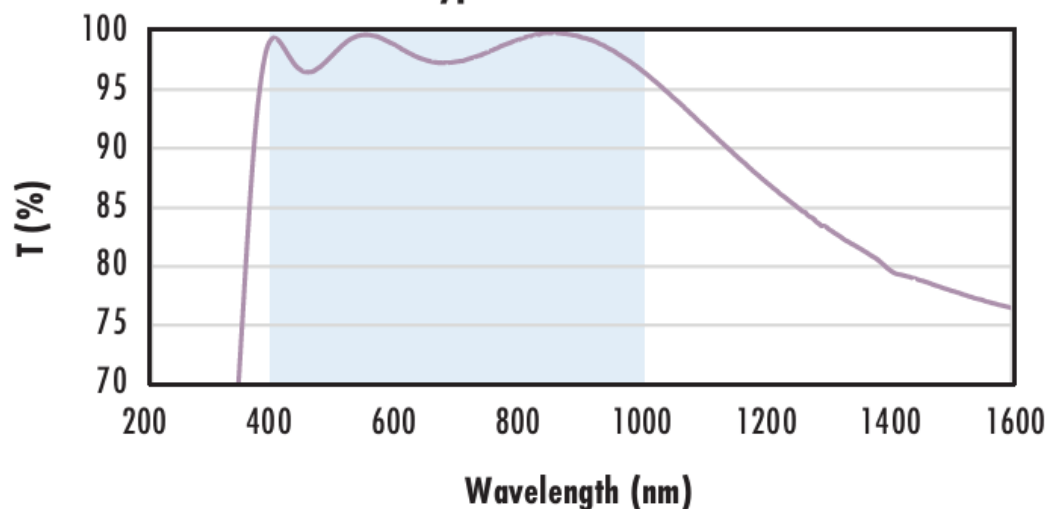

Typical transmission of a 3mm thick N-BK7 window with VIS-NIR (400-1000nm) coating at 0° AOI.

The blue shaded region indicates the coating design wavelength range, with the following specification:

$$R_{abs} \leq 0.25\% @ 880nm$$

$$R_{avg} \leq 1.25\% @ 400 - 870nm$$

$$R_{avg} \leq 1.25\% @ 890 - 1000nm$$

Data outside this range is not guaranteed and is for reference only.

[Click Here to Download Data](#)

N-BK7 with VIS 0° Coating Typical Transmission

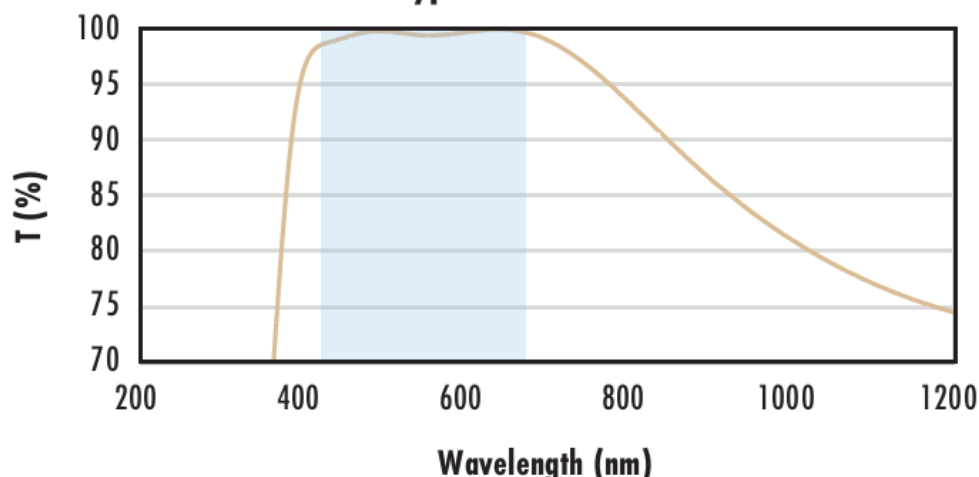

Typical transmission of a 3mm thick N-BK7 window with VIS 0° (425-675nm) coating at 0° AOI.

The blue shaded region indicates the coating design wavelength range, with the following specification:

$$R_{avg} \leq 0.4\% @ 425 - 675nm$$

Data outside this range is not guaranteed and is for reference only.

[Click Here to Download Data](#)

N-BK7 with YAG-BBAR Coating Typical Transmission

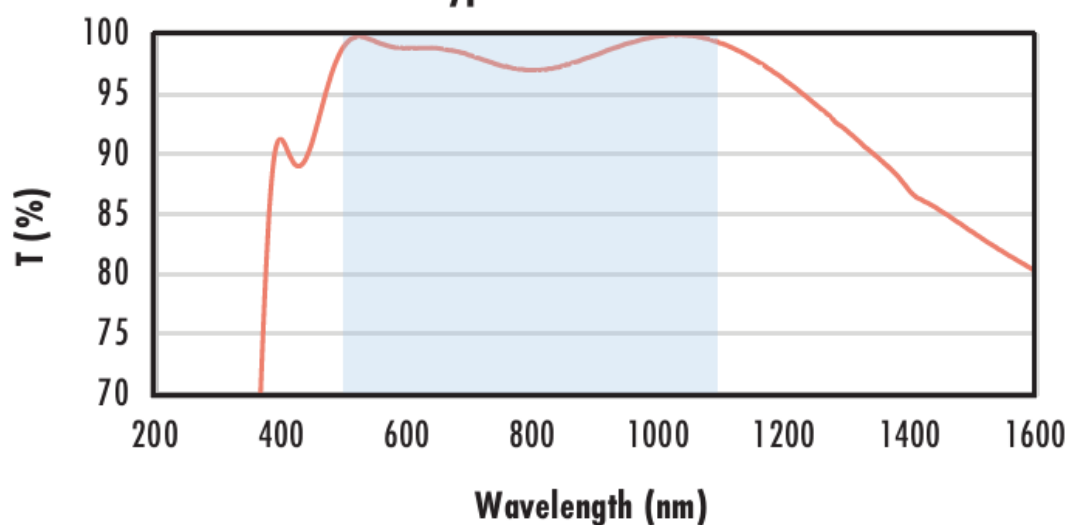

Typical transmission of a 3mm thick N-BK7 window with YAG-BBAR (500-1100nm) coating at 0° AOI.

The blue shaded region indicates the coating design wavelength range, with the following specification:

$$R_{abs} \leq 0.25\% @ 532nm$$

$$R_{abs} \leq 0.25\% @ 1064nm$$

$$R_{avg} \leq 1.0\% @ 500 - 1100nm$$

Data outside this range is not guaranteed and is for reference only.

[Click Here to Download Data](#)

N-BK7 with NIR I Coating Typical Transmission

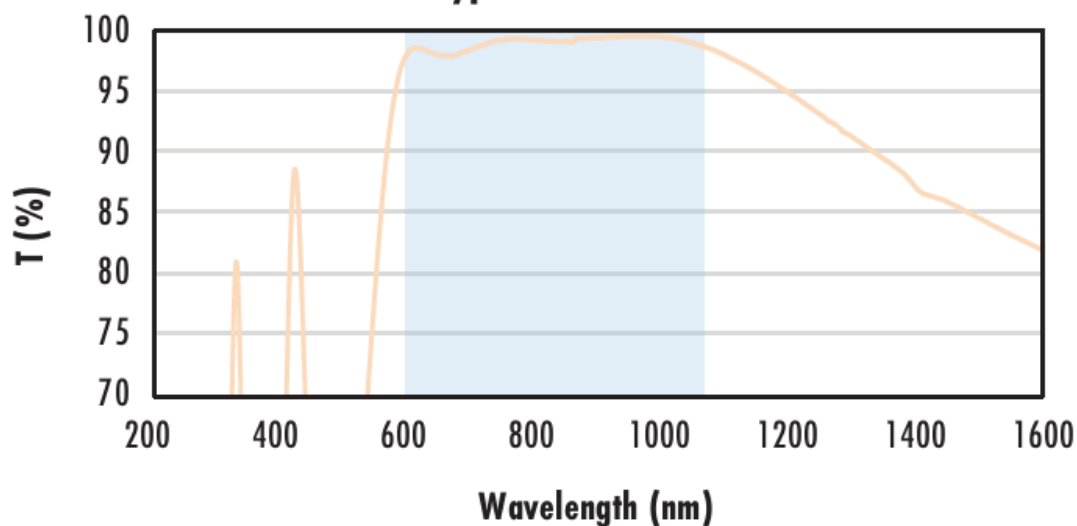

Typical transmission of a 3mm thick N-BK7 window with NIR I (600 - 1050nm) coating at 0° AOI.

The blue shaded region indicates the coating design wavelength range, with the following specification:

$$R_{avg} \leq 0.5\% @ 600 - 1050nm$$

Data outside this range is not guaranteed and is for reference only.

[Click Here to Download Data](#)

N-BK7 with NIR II Coating Typical Transmission

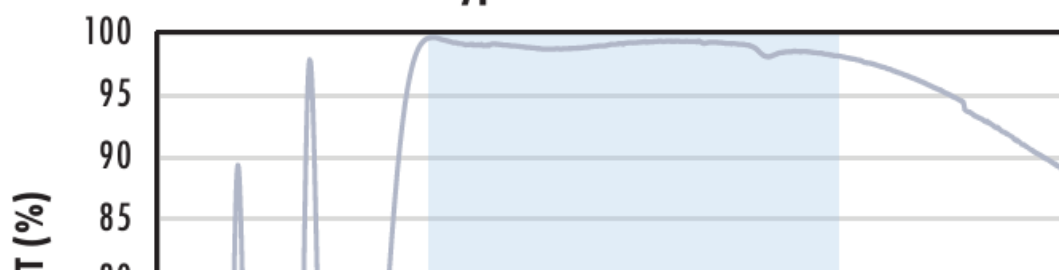

Typical transmission of a 3mm thick N-BK7 window with NIR II (750 - 1550nm) coating at 0° AOI.

The blue shaded region indicates the coating design wavelength range, with the following specification:

$$R_{abs} \leq 1.5\% @ 750 - 800nm$$

$$R_{abs} \leq 1.0\% @ 800 - 1550nm$$

$$R_{avg} \leq 0.7\% @ 750 - 1550nm$$

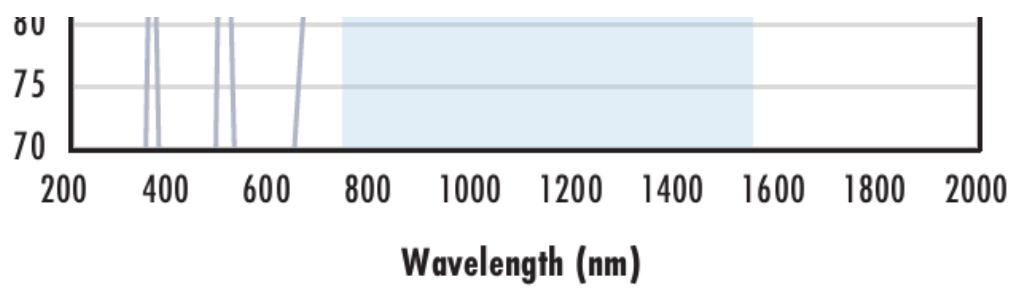

Data outside this range is not guaranteed and is for reference only.

[Click Here to Download Data](#)

Coating Curves