

20.0mm Optic Dia., Optic Mount



Optic Component Mounts

Stock **#64-559** **14 In Stock**

⊖ 1 ⊕ A\$52⁴⁰

ADD TO CART

Volume Pricing

Qty 1-9	A\$52.40 each
Qty 10+	A\$47.36 each
Need More?	Request Quote

Product Downloads

General

Fixed **Type:**
Circular **Type of Optics:**

Physical & Mechanical Properties

17.0 **Clear Aperture CA (mm):**
Outer Diameter (mm):

40.0

18.00 Thickness (mm):

Black Anodized Aluminum Construction:

12.00 Max. Thickness of Compatible Optics (mm):

Threading & Mounting

20.0 Size of Compatible Optics (mm):

M6 x 1.0, 1/4-20 Compatible Post:

Regulatory Compliance

Compliant RoHS 2015:

View Certificate of Conformance:

Compliant Reach 247:

Product Details

- Simple Mounting Arrangement
- Metric and English Configurations
- Black Anodized Aluminum Construction
- Posts and Post Holders Required for Mounting

Optic Component Mounts are designed to hold lenses, filters, mirrors, and other optical components. The included retainer ring securely holds the component in place. Optic Component Mounts need the required posts and post holders for mounting to a breadboard. Both English (1/4-20) and Metric (M6) standard posts are accepted by the mounts. These mounts are constructed of black anodized aluminum in a simple mounting arrangement.

Technical Information

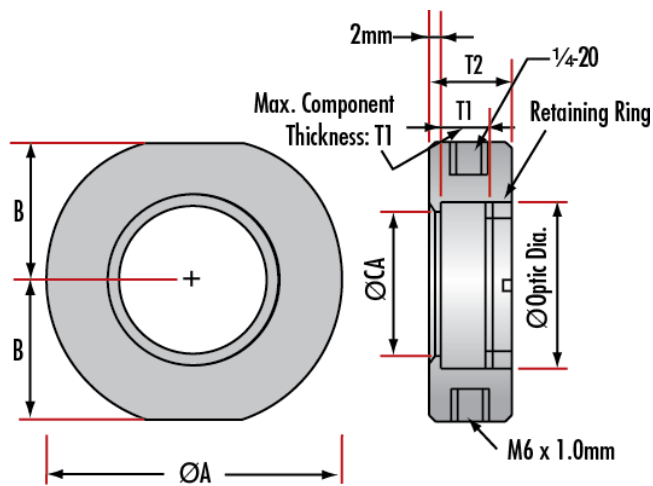

Maximum Optic Diameter	Clear Aperture (CA)	Mount Diameter A	B	Maximum Optic Thickness T1	Mount Thickness T2	Stock No.
5	4	30	13.5	5.7	12	#64-551
6	5	30	13.5	5.7	12	#64-552
9	6	30	13.5	6	12	#64-553
10	7	30	13.5	6	12	#64-554
12	9	35	16.0	10	16	#64-555
12.7	9.5	35	16.0	10	16	#64-556
15	12	35	16.0	10	16	#64-557
18	15	40	19.0	12	18	#64-558
20	17	40	19.0	12	18	#64-559
25	22	45	21.5	10	16	#64-560
25.4	22	45	21.5	10	16	#64-561
25.4	22	45	21.5	13	19	#65-562
30	26	50	24.0	6	12	#64-563
30	26	50	24.0	12	18	#64-564
38.1	34	60	29.0	12	18	#64-565
40	36	60	29.0	12	18	#64-566
50	46	70	34.0	12	18	#64-567
50	46	70	34.0	18	24	#64-568
50.8	46	70	34.0	12	28	#64-569

76.2	71	100	49	20	26	#64-570
□						

;