

[See all 27 Products in Family](#)

203.2mm Clear Aperture 40R/40T, Pellicle Beamsplitter



Pellicle Beamsplitters

Stock #22-590 [CONTACT US](#)

A\$4,544⁰⁰

ADD TO CART

Volume Pricing

Qty 1-4	A\$4,544.00 each
Qty 5-9	A\$4,318.40 each
Qty 10+	A\$4,089.60 each
Need More?	Request Quote

Product Downloads

General

Pellicle Beamsplitter **Type:**

Physical & Mechanical Properties

203.2 **Clear Aperture CA (mm):**

Pellicle **Construction:**

222.25 Diameter (mm):

Black Anodized Aluminum Housing:

2 +0.3/-0.0 Thickness (μm):

Optical Properties

Metal/Dielectric Coating:

40/40 @ 400 - 700nm Coating Specification:

1.5 Index of Refraction (n_d):

40/40 \pm 5% Reflection/Transmission Ratio (R/T):

Nitrocellulose Substrate:

40-20 Surface Quality:

400 - 700 Wavelength Range (nm):

Threading & Mounting

9.53 Mount Thickness (mm):

6-32 Mounting Threads:

Regulatory Compliance

[Compliant](#) RoHS 2015:

[View](#) Certificate of Conformance:

[Compliant](#) REACH 241:

Product Details

- No Ghost Images from Second Surface Reflections
- No Chromatic Aberration with Converging Beams
- No Change in Optical Path Length
- [Pellicle Beamsplitters for the Infrared \(IR\)](#) Also Available

Pellicle Beamsplitters are very thin nitrocellulose membranes bonded to lapped aluminum frames. They feature no ghost images from second surface reflections. To ease system integration, these beamsplitters offer mounting holes on the underside of the frame. Pellicle Beamsplitters are resistant to mechanical shock or climate variations but must be protected from dust and spray to avoid damage to the pellicle membrane. Please note, environments with a high level of humidity (>55%) can cause a temporary loss of tension in the pellicle membrane. The membrane will revert to normal tension if humidity is lowered.

Note: Extra care must be taken when handling.

Technical Information

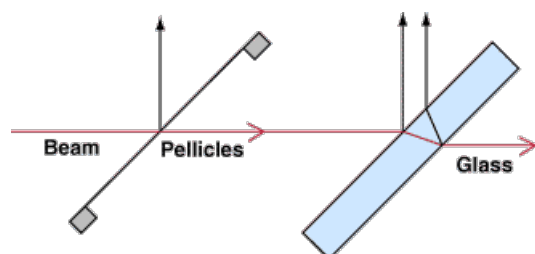
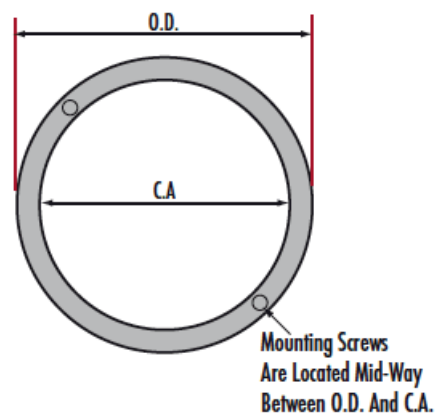

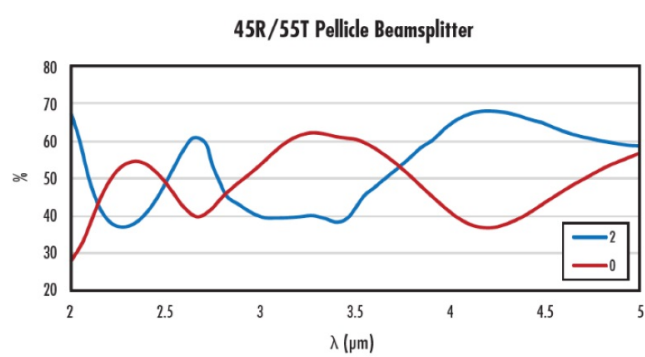
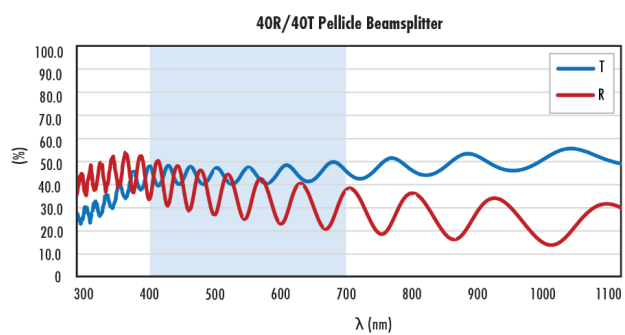
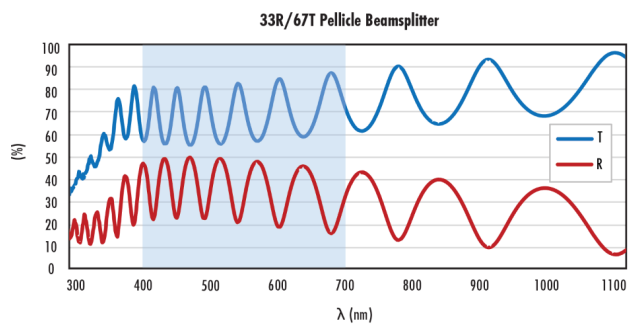
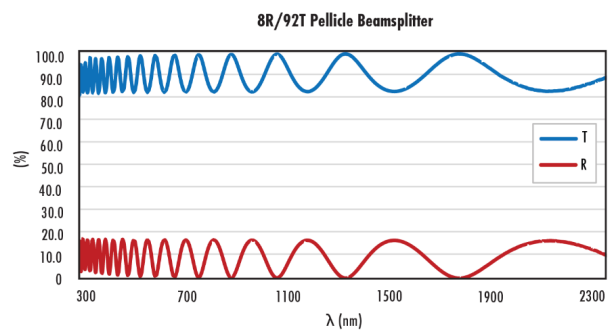
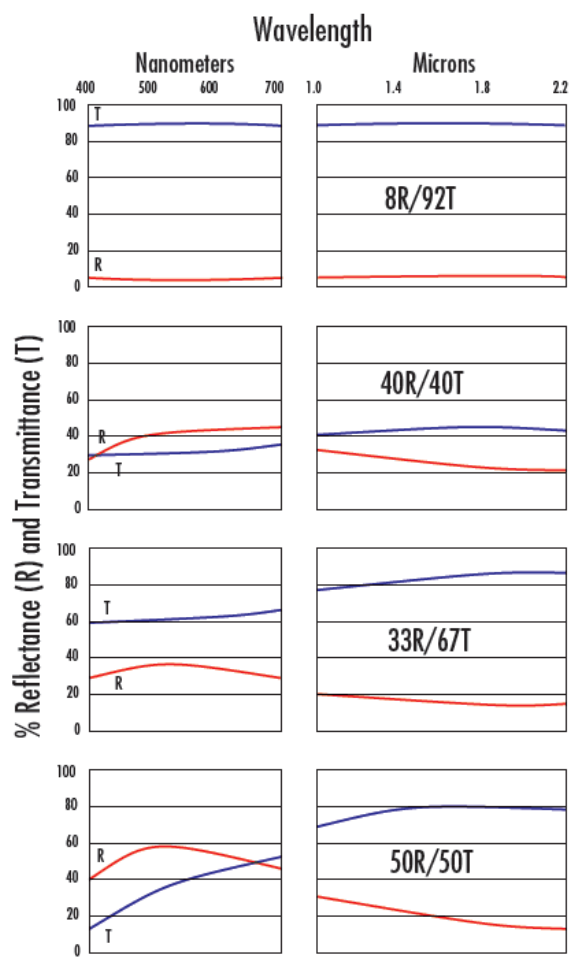
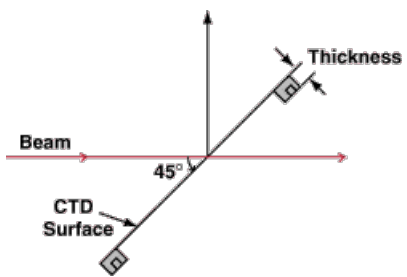

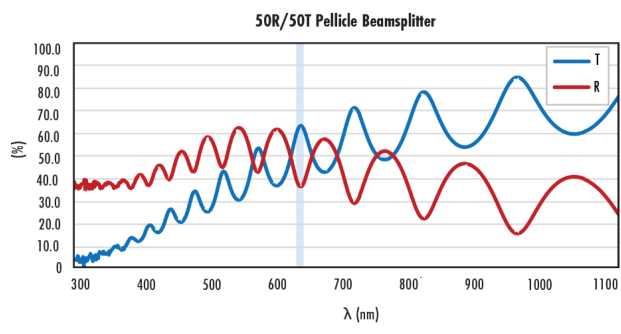

Special Handling

These optics require special handling to avoid damage and ensure long-term performance. Proper handling, cleaning, and storage are essential to maintain optical quality. Explore our [Optics Cleaning Resources](#) for step-by-step guides and best practices. For personalized assistance, [Email us](#) or [Chat](#) with our technical support team.



Component Handling Tools