

[See all 18 Products in Family](#)

TECHSPEC® 40mm N-SF11 MgF₂ Coated Equilateral Prism



Equilateral Prisms

Stock #65-593 **5 In Stock**

- 1 + A\$492⁰⁰

ADD TO CART

Volume Pricing	
Qty 1-5	A\$492.80 each
Qty 6-25	A\$393.60 each
Qty 26-49	A\$369.60 each
Need More?	Request Quote

Product Downloads

General

Equilateral Prism **Type:**

Physical & Mechanical Properties

40.00 **Length of Face (mm):**

40.00 **Length (mm):**

Dimensional Tolerance (mm):

±0.1

Optical Properties

MgF₂ (400-700nm) **Coating:**

[N-SF11](#) **Substrate:**

40-20 **Surface Quality:**

±2 **Angle Tolerance (arcmin):**

Dispersion **Image Orientation:**

R_{avg} ≤ 1.75% @ 400 - 700nm **Coating Specification:**

400 - 700 **Wavelength Range (nm):**

2.50 **Power (fringes) @ 632.8nm:**

0.50 **Irregularity (fringes) @ 632.8nm:**

Regulatory Compliance

[View](#) **Certificate of Conformance:**

Product Details

- Ideal for Light Dispersion
- Sizes Ranging from 5 - 50mm
- Available Uncoated or Anti-Reflection Coated
- Additional [Equilateral Prism](#) Options Available

TECHSPEC® Equilateral Prisms feature three equal 60° angles and are often referred to as dispersing prisms. Equilateral prisms are ideal for wavelength separating applications and light dispersion. These prisms are available in sizes ranging from 5-50mm. Our TECHSPEC® Equilateral Prisms are offered uncoated or with a single layer MgF2 anti-reflection coating. Additional [Equilateral Prism](#) options are available.

Technical Information

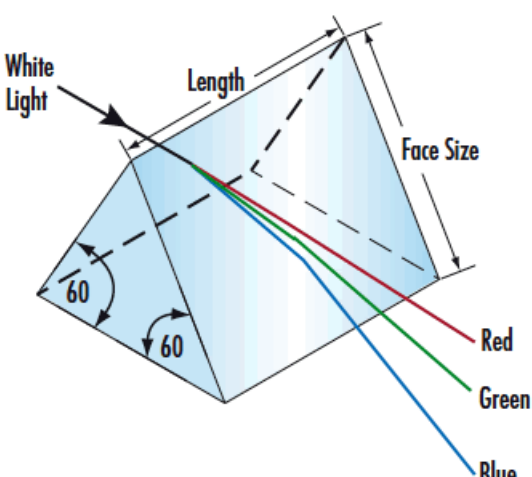

Coating Curves