

**TECHSPEC® 50mm, f/5.6 Ci Series Fixed Focal Length Lens**



50mm Focal Length

Stock **#86-617** **8 In Stock**

⊖ 1 ⊕ **A\$297<sup>00</sup>**

**ADD TO CART**

Volume Pricing

Qty 1-24	<b>A\$297.00</b> each
Qty 25+	<b>A\$268.00</b> each
Need More?	<a href="#">Request Quote</a>

Product Downloads

**General**

Ci Series **Product Family:**

Fixed Focal Length Lens **Type:**

**Physical & Mechanical Properties**

Fixed **Iris Option:**

**Length (mm):**

49.50

Maximum Diameter (mm):

30.5

Outer Diameter (mm):

30.5

Weight (g):

63

Maximum Rear Protrusion (mm):

2.06

Diameter (mm):

26.50

## Optical Properties

Horizontal Field of View @ Max Sensor Format:

42.8mm - 10.0°

Field of View at Max Sensor Format:

Horizontal: 42.7mm - 10°

Vertical: 32mm - 7.5°

Diagonal: 53.5mm - 12.5°

Horizontal Field of View, 2/3" Sensor:

42.8mm - 10.0°

Horizontal Field of View, 1/1.8" Sensor:

35.0mm - 8.2°

Horizontal Field of View, 1/2" Sensor:

31.1mm - 7.3°

Horizontal Field of View, 1/2.5" Sensor:

28.2mm - 6.6°

Horizontal Field of View, 1/3" Sensor:

23.3mm - 5.5°

Horizontal Field of View, 1/4" Sensor:

17.5mm - 4.1°

Maximum Image Circle (mm):

11.00

Numerical Aperture NA, Object Side:

0.0155

Number of Elements (Groups):

6 (4)

Focal Length FL (mm):

50.00

Working Distance (mm):

250 - ∞

Aperture (f/#):

f/5.6

Coating:

425 - 675nm BBAR

Coating Specification:

425 - 675nm BBAR

Entrance Pupil Position (mm):

35.62

Object Space Principal Plane (mm):

39.89

Image Space Principal Plane (mm):

-36.26

Maximum Distortion (%):

0.26

Exit Pupil Position (mm):

-40.93

Lens Wavelength Range:

VIS

## Sensor

Maximum Sensor Format:

2/3"

Pixel Size (µm):

2.74

## Threading & Mounting

Filter Thread:

M30.5 x 0.50 (Female)

Filter Thread Adapter:

[#89-943 \(Required\)](#)

Front Thread:

M30.5 x 0.5 (Male)

Mount:

C-Mount

## Environmental & Durability Factors

**Storage Temperature (°C):**  
-20 to +60

**Type of Ruggedization:**  
Industrial (Fixed Aperture with Simplified Mechanics)

## Regulatory Compliance

**RoHS 2015:**  
Compliant

**REACH 201:**  
Compliant

**Certificate of Conformance:**  
[View](#)

## Product Details

These compact lenses are designed specifically for volume integration into applications such as analytical medical devices, including benchtop-based blood analyzers. For customized  $f\#$  versions to best suit your instrumentation application needs and to discuss volume requirements, please [contact us](#).

- Up to 2/3", C-Mount Lens
- Up to 7.5 MegaPixels, 2.8 $\mu$ m Pixel Size Sensors
- Instrumentation (Ci) Versions of our C Series Lenses with Streamlined Mechanical Designs and Fixed Apertures
- 3.5mm to 50mm Focal Length
- **Ruggedized (Cr) Designs** Also Available

TECHSPEC® Ci Series Fixed Focal Length Lenses are a streamlined version of our C Series Fixed Focal Length Lenses. They feature the same low lens-to-lens variation and broadband anti-reflection (BBAR) coating for maximum light transmission, while offering reduced weight and size. An adjustable, lockable focus allows for setting and locking the best focus position for instrumentation integration. TECHSPEC® Ci Series Fixed Focal Length Lenses are designed specifically for volume integration into applications such as factory inspection and automation to benchtop biomedical devices. The Ci Series offers a wide range of aperture options, ensuring maximum flexibility of resolution, throughput, and depth of field.

Edmund Optics has created a family of high performance optical designs (the C Series family) and developed 6 customized optomechanical solutions targeted for specific applications. These lens sub-families utilize the same optics as the C Series lenses providing the same optical performance in a variety of optomechanical solutions to meet your application requirements:

- **C Series:** Features locking cam focus and iris adjustment and is the most adjustable version of these optical designs; they are the typical high quality machine vision lenses. Also available with a [VIS-NIR Broadband Anti-Reflection \(BBAR\) Coating](#).
- **Ci Series:** Simplified mechanics featuring fixed apertures with compact housing. [Industrial Ruggedization](#) for reduced size, cost, and locked focus.
- **Cr Series:** All optics glued in place and a locking C-clamp focus ring. [Stabilized Ruggedization](#) for reduced pixel shift and improved focus stability.
- **Cx Series:** Modular, flexible mechanics allows lenses to be taken apart for easy integration of accessories such as liquid lenses, apertures, and more.
- **Liquid Lens Cx Series:** Designed with an integrated liquid lens for quick autofocus.
- **Cw Series:** Waterproof, designed to meet IEC [Ingress Protection](#) Code IPX7 and IPX9K.

## Technical Information

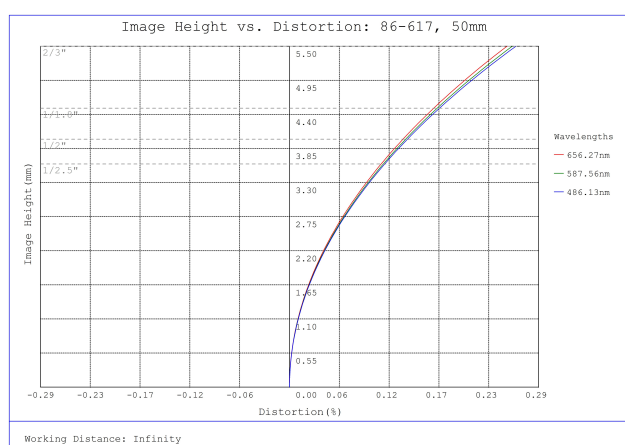

#86-617, 50mm,  $f/5.6$  Ci Series Fixed Focal Length Lens, Distortion Plot

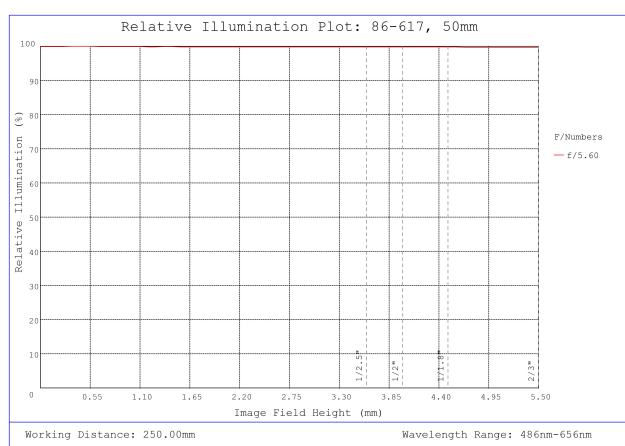

#86-617, 50mm,  $f/5.6$  Ci Series Fixed Focal Length Lens, Relative Illumination Plot

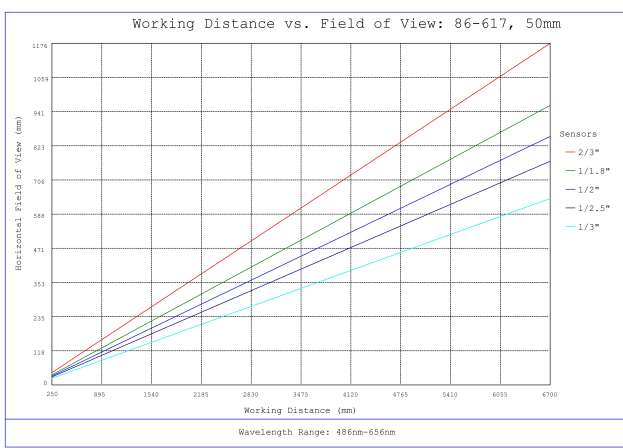

#86-617, 50mm, f/5.6 Ci Series Fixed Focal Length Lens, Working Distance versus Field of View Plot

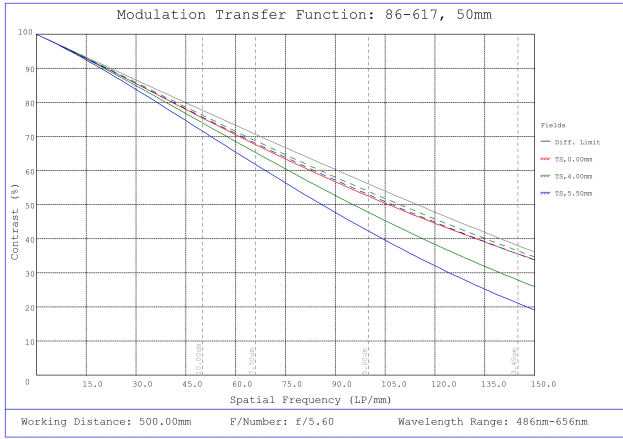

#86-617, 50mm, f/5.6 Ci Series Fixed Focal Length Lens, Modulated Transfer Function (MTF) Plot, 500mm Working Distance, f5.6

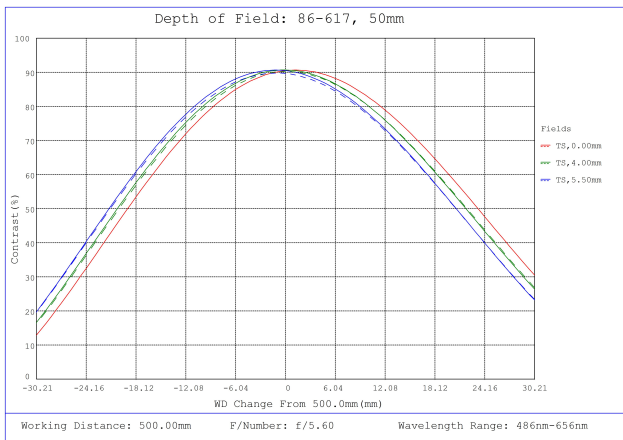

#86-617, 50mm, f/5.6 Ci Series Fixed Focal Length Lens, Depth of Field Plot, 500mm Working Distance, f5.6

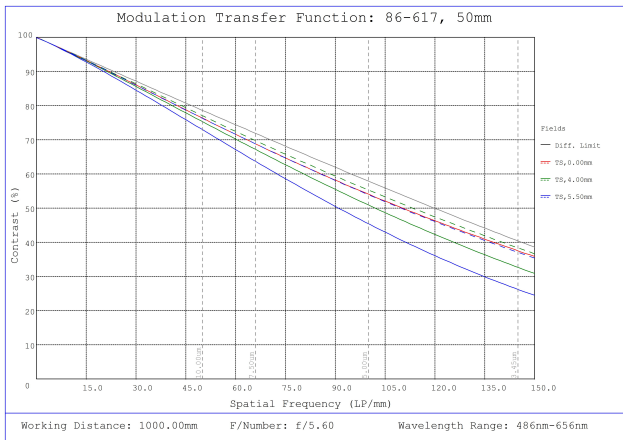

#86-617, 50mm, f/5.6 Ci Series Fixed Focal Length Lens, Modulated Transfer Function (MTF) Plot, 1000mm Working Distance, f5.6

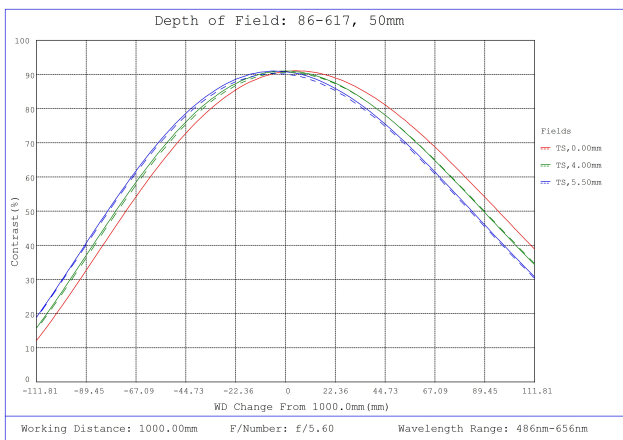

#86-617, 50mm, f/5.6 Ci Series Fixed Focal Length Lens, Depth of Field Plot, 1000mm Working Distance, f5.6

Focal Length	A	B	C	D
6mm	M34.0 x 0.5	47.8mm	34mm	1.17mm
12mm	M22.0 x 0.75	29.0mm	22mm	0.96mm
16mm	M22.0 x 0.75	40.8mm	22mm	1.09mm
25mm	M22.0 x 0.75	29.9mm	22mm	1.33mm
35mm	M25.5 x 0.5	41mm	22.5mm	3.82mm
50mm	M30.5 x 0.5	49.5mm	30.5mm	2.06mm



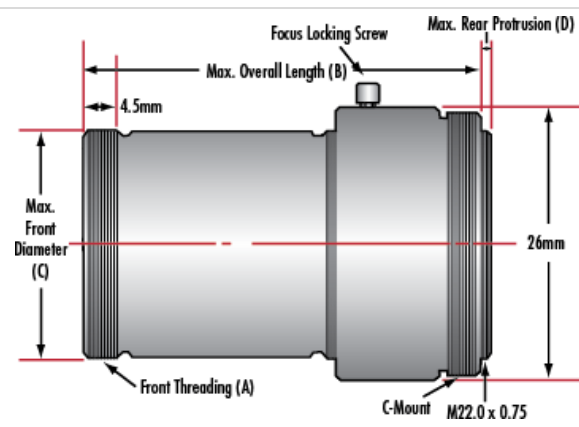

## Compatible Cameras