

TECHSPEC® 6mm, f/4 Ci Series Fixed Focal Length Lens



6mm Focal Length

Stock #86-594 **20+ In Stock**

⊖ 1 ⊕ A\$297⁰⁰

ADD TO CART

Volume Pricing

| | |
|------------|-------------------------------|
| Qty 1-24 | A\$297.00 each |
| Qty 25+ | A\$268.00 each |
| Need More? | Request Quote |

Product Downloads

General

Ci Series **Product Family:**

Fixed Focal Length Lens **Type:**

Physical & Mechanical Properties

Fixed **Iris Option:**

Length (mm):

47.80

34 **Maximum Diameter (mm):**

34 **Outer Diameter (mm):**

64 **Weight (g):**

1.17 **Maximum Rear Protrusion (mm):**

26.50 **Diameter (mm):**

Optical Properties

Horizontal Field of View @ Max Sensor Format:

110.2mm - 62.1°

Field of View at Max Sensor Format:

Horizontal: 110mm - 62.1°

Vertical: 80.4mm - 47.8°

Diagonal: 141.9mm - 75°

Horizontal Field of View, 1/1.8" Sensor:

110.2mm - 62.1°

Horizontal Field of View, 1/2" Sensor:

96.8mm - 55.9°

Horizontal Field of View, 1/2.5" Sensor:

86.9mm - 51.0°

Horizontal Field of View, 1/3" Sensor:

71.0mm - 42.7°

Horizontal Field of View, 1/4" Sensor:

52.6mm - 32.4°

Maximum Image Circle (mm):

9.00

Numerical Aperture NA, Object Side:

0.0086

Number of Elements (Groups):

9 (7)

Focal Length FL (mm):

6.00

Working Distance (mm):

75 - ∞

Aperture (f/#):

f/4

Coating:

425 - 675nm BBAR

Coating Specification:

425 - 675nm BBAR

Entrance Pupil Position (mm):

16.08

Object Space Principal Plane (mm):

21.35

Image Space Principal Plane (mm):

6.60

Maximum Distortion (%):

-6.82

Exit Pupil Position (mm):

-25.52

Lens Wavelength Range:

VIS

Sensor

Maximum Sensor Format:

1/1.8"

Pixel Size (µm):

2.74

Threading & Mounting

Filter Thread:

M43 x 0.75 (Female)

Filter Thread Adapter:

[#89-940 \(Required\)](#)

Front Thread:

M34.0 x 0.5 (Male)

Mount:

C-Mount

Environmental & Durability Factors

Storage Temperature (°C):

-20 to +60

Type of Ruggedization:

Industrial (Fixed Aperture with Simplified Mechanics)

Regulatory Compliance

Compliant

RoHS 2015:

Compliant

REACH 201:

View

Certificate of Conformance:

Product Details

These compact lenses are designed specifically for volume integration into applications such as analytical medical devices, including benchtop-based blood analyzers. For customized $f\#$ versions to best suit your instrumentation application needs and to discuss volume requirements, please [contact us](#).

- Up to 2/3", C-Mount Lens
- Up to 7.5 MegaPixels, 2.8 μ m Pixel Size Sensors
- Instrumentation (Ci) Versions of our C Series Lenses with Streamlined Mechanical Designs and Fixed Apertures
- 3.5mm to 50mm Focal Length
- **Ruggedized (Cr) Designs** Also Available

TECHSPEC® Ci Series Fixed Focal Length Lenses are a streamlined version of our C Series Fixed Focal Length Lenses. They feature the same low lens-to-lens variation and broadband anti-reflection (BBAR) coating for maximum light transmission, while offering reduced weight and size. An adjustable, lockable focus allows for setting and locking the best focus position for instrumentation integration. TECHSPEC® Ci Series Fixed Focal Length Lenses are designed specifically for volume integration into applications such as factory inspection and automation to benchtop biomedical devices. The Ci Series offers a wide range of aperture options, ensuring maximum flexibility of resolution, throughput, and depth of field.

Edmund Optics has created a family of high performance optical designs (the C Series family) and developed 6 customized optomechanical solutions targeted for specific applications. These lens sub-families utilize the same optics as the C Series lenses providing the same optical performance in a variety of optomechanical solutions to meet your application requirements:

- **C Series:** Features locking cam focus and iris adjustment and is the most adjustable version of these optical designs; they are the typical high quality machine vision lenses. Also available with a **VIS-NIR Broadband Anti-Reflection (BBAR) Coating**.
- **Ci Series:** Simplified mechanics featuring fixed apertures with compact housing. **Industrial Ruggedization** for reduced size, cost, and locked focus.
- **Cr Series:** All optics glued in place and a locking C-clamp focus ring. **Stabilized Ruggedization** for reduced pixel shift and improved focus stability.
- **Cx Series:** Modular, flexible mechanics allows lenses to be taken apart for easy integration of accessories such as liquid lenses, apertures, and more.
- **Liquid Lens Cx Series:** Designed with an integrated liquid lens for quick autofocus.
- **Cw Series:** Waterproof, designed to meet IEC **Ingress Protection** Code IPX7 and IPX9K.

Technical Information

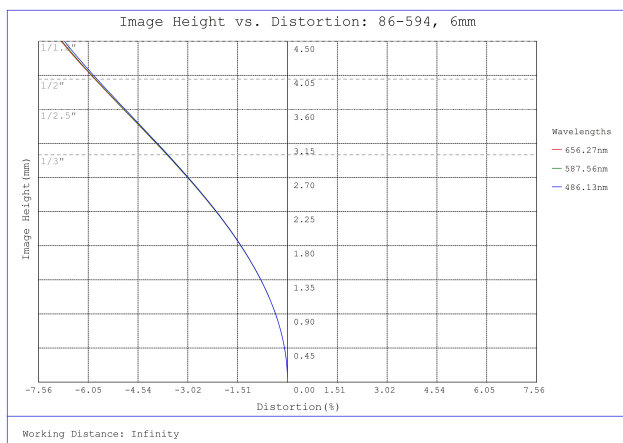

#86-594, 6mm, f/4 Ci Series Fixed Focal Length Lens, Distortion Plot

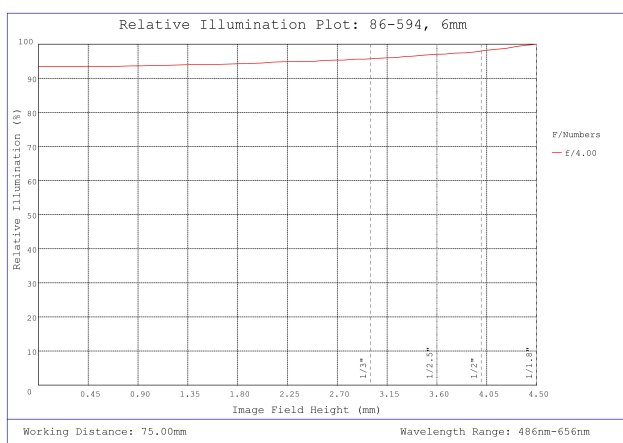

#86-594, 6mm, f/4 Ci Series Fixed Focal Length Lens, Relative Illumination Plot

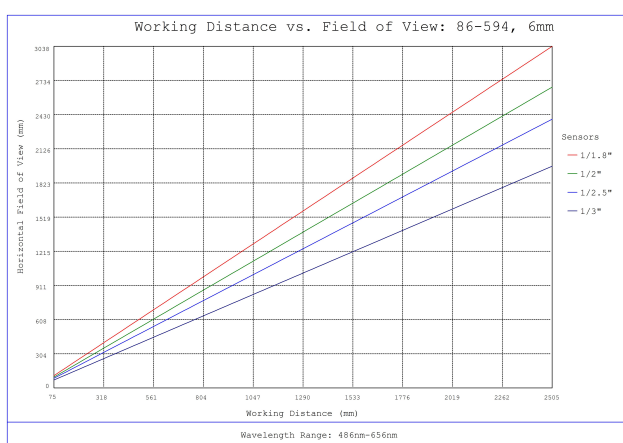

#86-594, 6mm, f/4 Ci Series Fixed Focal Length Lens, Working Distance versus Field of View Plot

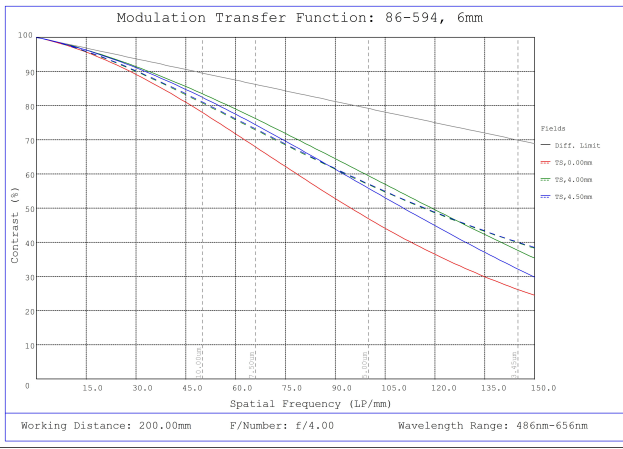

#86-594, 6mm, f/4 Ci Series Fixed Focal Length Lens, Modulated Transfer Function (MTF) Plot, 200mm Working Distance, f4

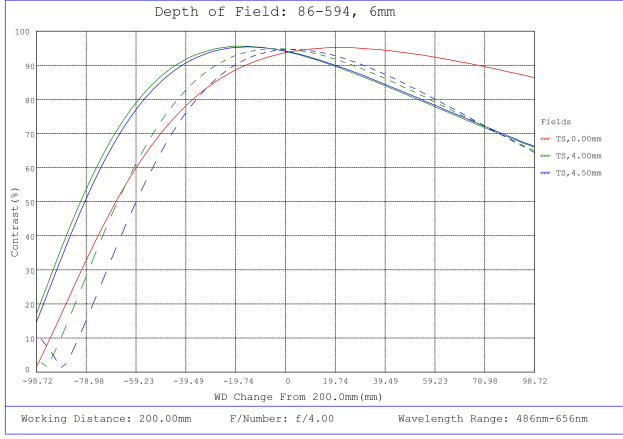

#86-594, 6mm, f/4 Ci Series Fixed Focal Length Lens, Depth of Field Plot, 200mm Working Distance, f4

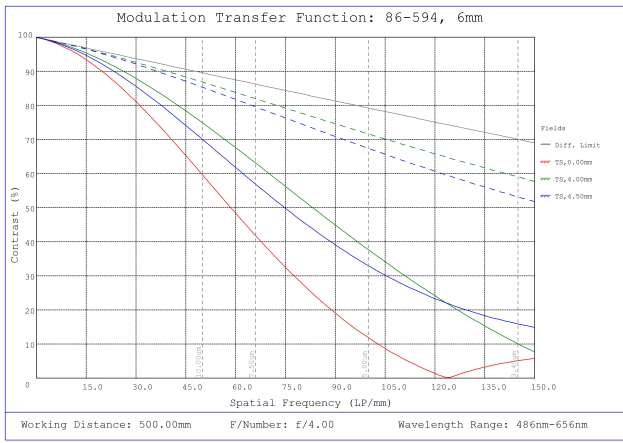

#86-594, 6mm, f/4 Ci Series Fixed Focal Length Lens, Modulated Transfer Function (MTF) Plot, 500mm Working Distance, f4

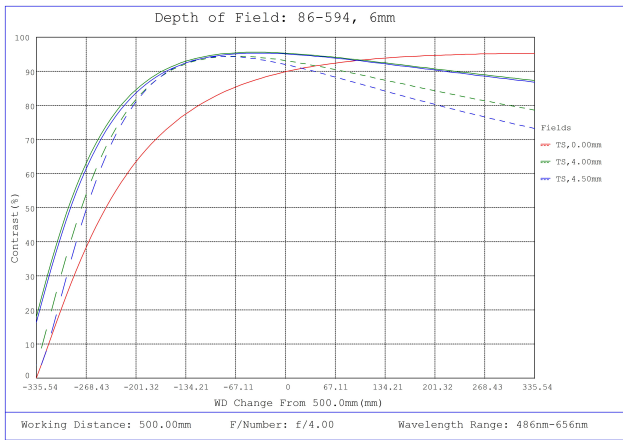

#86-594, 6mm, f/4 Ci Series Fixed Focal Length Lens, Depth of Field Plot, 500mm Working Distance, f4

| Focal Length | A | B | C | D |
|--------------|--------------|--------|--------|--------|
| 6mm | M34.0 x 0.5 | 47.8mm | 34mm | 1.17mm |
| 12mm | M22.0 x 0.75 | 29.0mm | 22mm | 0.96mm |
| 16mm | M22.0 x 0.75 | 40.8mm | 22mm | 1.09mm |
| 25mm | M22.0 x 0.75 | 29.9mm | 22mm | 1.33mm |
| 35mm | M25.5 x 0.5 | 41mm | 22.5mm | 3.82mm |
| 50mm | M30.5 x 0.5 | 49.5mm | 30.5mm | 2.06mm |

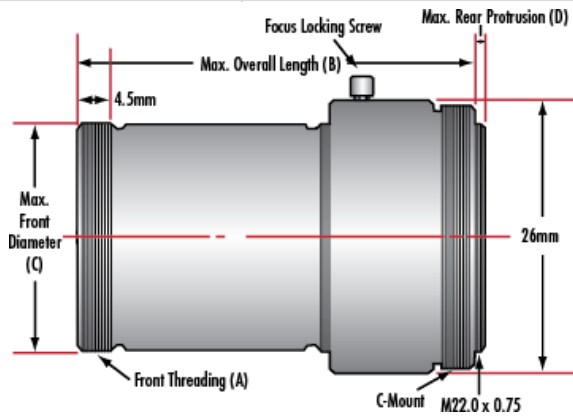

Compatible Cameras
