

203.2mm/8.0" Optic Dia., Optical Cell Kinematic Mount



Stock #36-476 [CONTACT US](#)

- 1 + A\$5,248⁰⁰

ADD TO CART

Volume Pricing

Qty 1-4	A\$5,248.00 each
Qty 5-9	A\$4,630.88 each
Qty 10-25	A\$4,261.44 each
Need More?	Request Quote

Product Downloads

General

Adjustable - Tip-Tilt **Type:**

Circular **Type of Optics:**

5° **Range:**

8.06 Inner Diameter (inches):

Optic Holding Style:
Three Spring-Loaded Clips

Physical & Mechanical Properties

7.62 Clear Aperture CA (inches):

193.5 Clear Aperture CA (mm):

158.8 Optical Centerline (mm):

12.00 x 6.00 x 11.50 Dimensions (inches):

304.8 x 152.4 x 292.1 Dimensions (mm):

27.0 Weight (lbs):

Construction:
Black Anodized Aluminum, Stainless Steel

8.00 Diameter of Compatible Optics (inches):

6.25 Optical Centerline (inches):

39.5 Max. Thickness of Compatible Optics (mm):

0.031 Adjustment Screw Pitch (inches):

Threading & Mounting

203.2 Size of Compatible Optics (mm):

Regulatory Compliance

Compliant RoHS 2015:

View Certificate of Conformance:

Product Details

- Robust Kinematic Mounts for Larger Diameter Optics
- Ball Pivot and Fine Pitch Screws Provide Pitch and Roll
- 50% Greater Resolution than Micrometer Adjustments

Optical Cell Kinematic Mounts provide highly stable kinematic movement with two axis tilt (pitch and roll) provided by a precise ball pivot adjustment and an orthogonal three-point suspension. Adjustment is made by three 64-pitch screws (two 64-pitch screws for 1-2" diameter model). For the 6" diameter model, adjustment is made by two 64-pitch screws for and with three 32-pitch screws for 8" up to 12.5" diameter models. Optical Cell Kinematic Mounts feature fine pitch screws, which permit 50% greater resolution than a micrometer. An angled base on the mount allows for stand-alone installation and mounting. These mounts have integral optic cell design allowing optics to be held undistorted.

Note: For mounting 12" diameter optics in our 12.5" Diameter Optical Mount, use the 12.5" to 12" Adapter Kit (#12-226). The Adapter Kit and 12.5" Diameter Optical Mount are offered together as #12-227.

Technical Information

Optic Diameter	A	B	C	D	E	F	G	H	I	J	K	Stock No.
1-2"	2.25-20 TPI	3.75	2.00	2.00	0.38	2.00	3.50	0.28	-	2.12	-	#53-964
3"	3.25-20 TPI	5.75	3.00	4.00	1.25	3.38	6.25	0.28	-	5.00	-	#53-965
4.25"	4.625-20 TPI	5.75	3.00	4.00	1.25	3.38	6.25	0.28	-	5.00	-	#57-872

1" - 4.25" Angled Optical Cell Mounts



Units: inches

4.25" Straight Optical Cell Mount

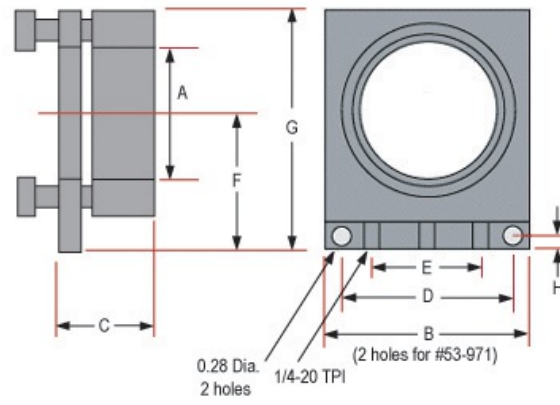

Units: inches

Optic Diameter	A	B	C	D	E	F	G	H	I	J	K	Stock No.
6"	6.187-32 TPI	8.00	6.00	5.00	5.00	4.50	8.00	0.28	5.75	6.00	1.19	#36-474
8"	8.06	12.00	7.00	10.00	6.00	6.25	11.50	0.28	7.62	9.00	1.60	#36-476
10"	10.06	16.00	8.00	12.00	6.00	8.00	15.00	0.53	9.58	12.50	1.75	#36-478
12.5"	12.56	16.00	8.00	12.00	6.00	8.00	15.00	0.53	12.08	12.50	2.13	#36-480

8" - 12.5" Angled Optical Cell Mounts



Units: inches