

[See all 76 Products in Family](#)

TECHSPEC® 8.5mm, f/2.8 Ci Series Fixed Focal Length Lens



8.5mm Focal Length

Stock **#86-601** **4 In Stock**

⊖ 1 ⊕ A\$221⁰⁰

ADD TO CART

Volume Pricing

Qty 1-24	A\$221.00 each
Qty 25+	A\$200.00 each
Need More?	Request Quote

Product Downloads

General

Ci Series **Product Family:**
Fixed Focal Length Lens **Type:**

Physical & Mechanical Properties

Fixed **Iris Option:**
Length (mm):

33.98

26.5 **Maximum Diameter (mm):**

26.5 **Outer Diameter (mm):**

34 **Weight (g):**

0.6 **Maximum Rear Protrusion (mm):**

26.50 **Diameter (mm):**

Optical Properties

Horizontal Field of View @ Max Sensor Format:

128.6mm - 60.6°

Field of View at Max Sensor Format:

Horizontal: 124.9mm - 60.7°

Vertical: 88.9mm - 45°

Diagonal: 169.3mm - 77°

Horizontal Field of View, 2/3" Sensor:

128.6mm - 60.6°

Horizontal Field of View, 1/1.8" Sensor:

101.0mm - 49.2°

Horizontal Field of View, 1/2" Sensor:

88.3mm - 43.6°

Horizontal Field of View, 1/2.5" Sensor:

79.2mm - 39.5°

Horizontal Field of View, 1/3" Sensor:

64.6mm - 32.6°

Horizontal Field of View, 1/4" Sensor:

47.8mm - 24.4°

Maximum Image Circle (mm):

11.00

Numerical Aperture NA, Object Side:

0.0138

Number of Elements (Groups):

7 (5)

Focal Length FL (mm):

8.50

Working Distance (mm):

100 - ∞

Aperture (f/#):

f/2.8

Coating:

425 - 675nm BBAR

Coating Specification:

425 - 675nm BBAR

Entrance Pupil Position (mm):

8.22

Object Space Principal Plane (mm):

14.08

Image Space Principal Plane (mm):

6.67

Maximum Distortion (%):

-18.51

Exit Pupil Position (mm):

-12.23

Lens Wavelength Range:

VIS

Sensor

Maximum Sensor Format:

2/3"

Pixel Size (µm):

2.74

Threading & Mounting

Filter Thread:

M30.5 x 0.50 (Male)

Filter Thread Adapter:

[#89-932 \(Required\)](#)

Front Thread:

M22.0 x 0.5 (Male)

Mount:

C-Mount

Environmental & Durability Factors

Storage Temperature (°C):
-20 to +60

Type of Ruggedization:
Industrial (Fixed Aperture with Simplified Mechanics)

Regulatory Compliance

RoHS 2015:
Compliant

REACH 201:
Compliant

Certificate of Conformance:
[View](#)

Product Details

- Up to 2/3", C-Mount Lens
- Up to 7.5 MegaPixels, 2.8µm Pixel Size Sensors
- Instrumentation (Ci) Versions of our C Series Lenses with Streamlined Mechanical Designs and Fixed Apertures
- 3.5mm to 50mm Focal Length
- **Ruggedized (Cr) Designs** Also Available

TECHSPEC® Ci Series Fixed Focal Length Lenses are a streamlined version of our C Series Fixed Focal Length Lenses. They feature the same low lens-to-lens variation and broadband anti-reflection (BBAR) coating for maximum light transmission, while offering reduced weight and size. An adjustable, lockable focus allows for setting and locking the best focus position for instrumentation integration. TECHSPEC® Ci Series Fixed Focal Length Lenses are designed specifically for volume integration into applications such as factory inspection and automation to benchtop biomedical devices. The Ci Series offers a wide range of aperture options, ensuring maximum flexibility of resolution, throughput, and depth of field.

Edmund Optics has created a family of high performance optical designs (the C Series family) and developed 6 customized optomechanical solutions targeted for specific applications. These lens sub-families utilize the same optics as the C Series lenses providing the same optical performance in a variety of optomechanical solutions to meet your application requirements:

- **C Series:** Features locking cam focus and iris adjustment and is the most adjustable version of these optical designs; they are the typical high quality machine vision lenses. Also available with a **VIS-NIR Broadband Anti-Reflection (BBAR) Coating**.
- **Ci Series:** Simplified mechanics featuring fixed apertures with compact housing. **Industrial Ruggedization** for reduced size, cost, and locked focus.
- **Cr Series:** All optics glued in place and a locking C-clamp focus ring. **Stabilized Ruggedization** for reduced pixel shift and improved focus stability.
- **Cx Series:** Modular, flexible mechanics allows lenses to be taken apart for easy integration of accessories such as liquid lenses, apertures, and more.
- **Liquid Lens Cx Series:** Designed with an integrated liquid lens for quick autofocus.
- **Cw Series:** Waterproof, designed to meet IEC **Ingress Protection** Code IPX7 and IPX9K.

Technical Information

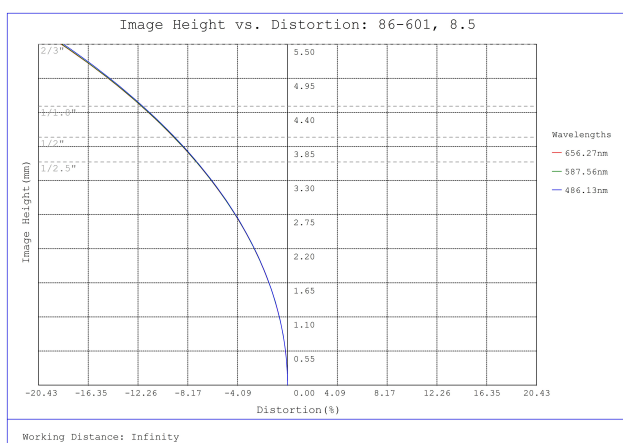

#86-601, 8.5mm, f/2.8 Ci Series Fixed Focal Length Lens, Distortion Plot

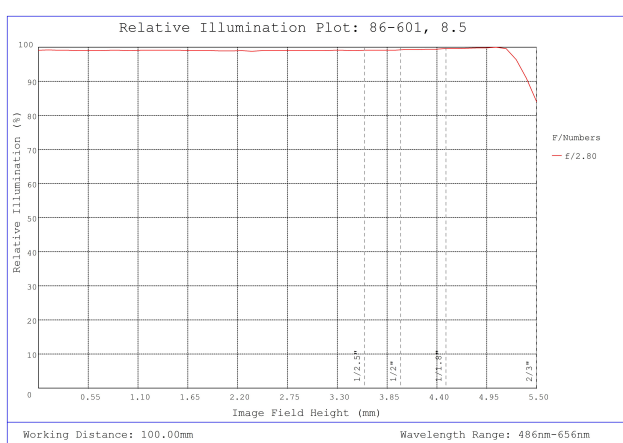

#86-601, 8.5mm, f/2.8 Ci Series Fixed Focal Length Lens, Relative Illumination Plot

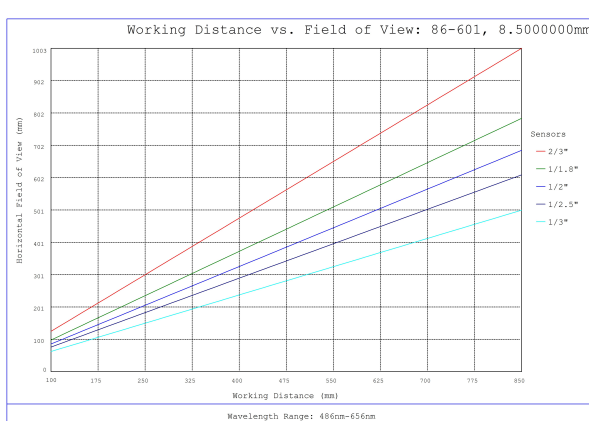

#86-601, 8.5mm, f/2.8 Ci Series Fixed Focal Length Lens, Working Distance versus Field of View Plot

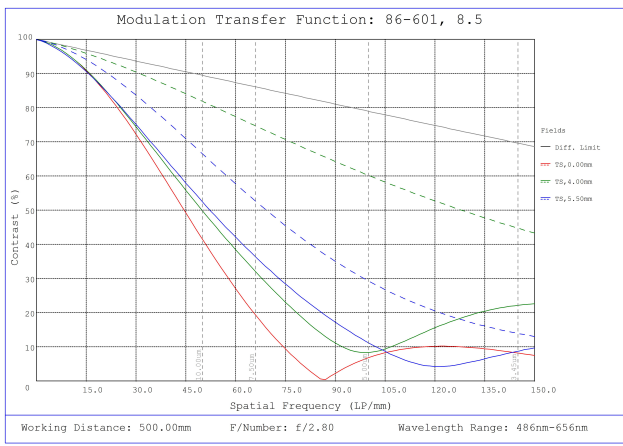

#86-601, 8.5mm, f/2.8 Ci Series Fixed Focal Length Lens, Modulated Transfer Function (MTF) Plot, 500mm Working Distance, f2.8

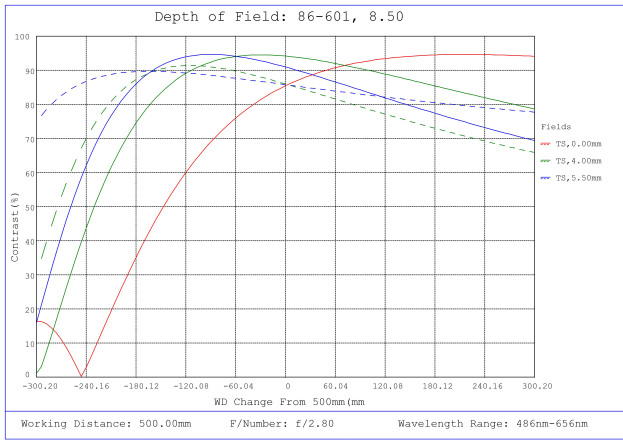

#86-601, 8.5mm, f/2.8 Ci Series Fixed Focal Length Lens, Depth of Field Plot, 500mm Working Distance, f2.8

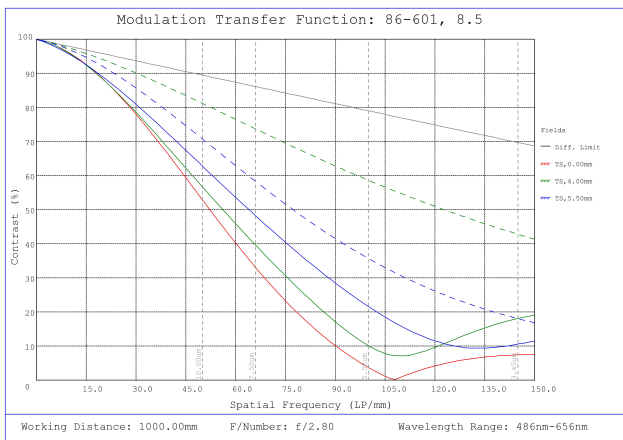

#86-601, 8.5mm, f/2.8 Ci Series Fixed Focal Length Lens, Modulated Transfer Function (MTF) Plot, 1000mm Working Distance, f2.8

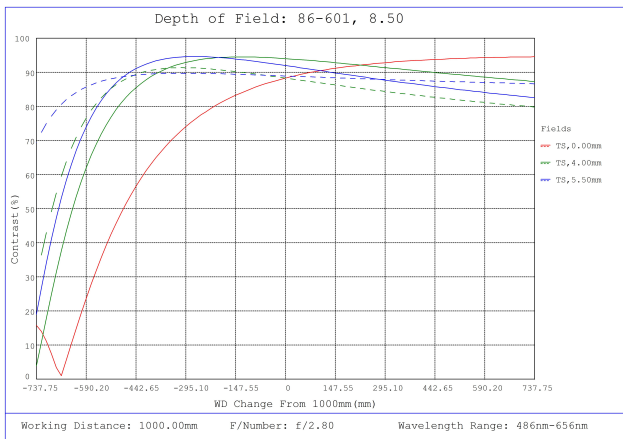

#86-601, 8.5mm, f/2.8 Ci Series Fixed Focal Length Lens, Depth of Field Plot, 1000mm Working Distance, f2.8

Focal Length	A	B	C	D
6mm	M34.0 x 0.5	47.8mm	34mm	1.17mm
12mm	M22.0 x 0.75	29.0mm	22mm	0.96mm
16mm	M22.0 x 0.75	40.8mm	22mm	1.09mm
25mm	M22.0 x 0.75	29.9mm	22mm	1.33mm
35mm	M25.5 x 0.5	41mm	22.5mm	3.82mm
50mm	M30.5 x 0.5	49.5mm	30.5mm	2.06mm

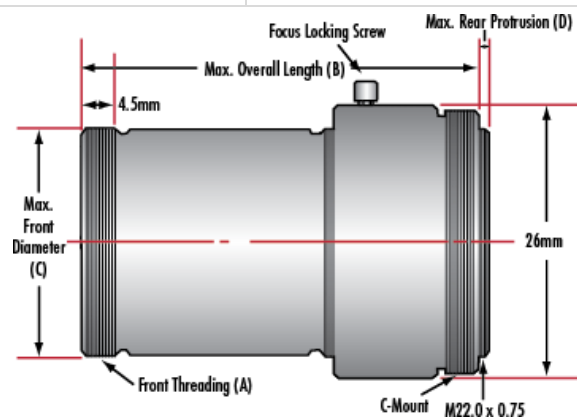

Compatible Cameras
