

**TECHSPEC® 8.5mm, f/8 Ci Series Fixed Focal Length Lens**



8.5mm Focal Length

Stock #86-604 **14 In Stock**

⊖ 1 ⊕ A\$221<sup>00</sup>

**ADD TO CART**

Volume Pricing	
Qty 1-24	A\$221.00 each
Qty 25+	A\$200.00 each
Need More?	<a href="#">Request Quote</a>

Product Downloads

**General**

Ci Series **Product Family:**  
Fixed Focal Length Lens **Type:**

**Physical & Mechanical Properties**

Fixed **Iris Option:**  
**Length (mm):**

33.98

26.5 **Maximum Diameter (mm):**

26.5 **Outer Diameter (mm):**

34 **Weight (g):**

0.6 **Maximum Rear Protrusion (mm):**

26.50 **Diameter (mm):**

## Optical Properties

**Horizontal Field of View @ Max Sensor Format:**

128.6mm - 60.6°

**Field of View at Max Sensor Format:**

Horizontal: 124.9mm - 60.7°

Vertical: 88.9mm - 45°

Diagonal: 168.8mm - 77°

**Horizontal Field of View, 2/3" Sensor:**

128.6mm - 60.6°

**Horizontal Field of View, 1/1.8" Sensor:**

101.0mm - 49.2°

**Horizontal Field of View, 1/2" Sensor:**

88.3mm - 43.6°

**Horizontal Field of View, 1/2.5" Sensor:**

79.2mm - 39.5°

**Horizontal Field of View, 1/3" Sensor:**

64.6mm - 32.6°

**Horizontal Field of View, 1/4" Sensor:**

47.8mm - 24.4°

**Maximum Image Circle (mm):**

11.00

**Numerical Aperture NA, Object Side:**

0.0048

**Number of Elements (Groups):**

7 (5)

**Focal Length FL (mm):**

8.50

**Working Distance (mm):**

100 - ∞

**Aperture (f/#):**

f/8

**Coating:**

425 - 675nm BBAR

**Coating Specification:**

425 - 675nm BBAR

**Entrance Pupil Position (mm):**

8.22

**Object Space Principal Plane (mm):**

14.08

**Image Space Principal Plane (mm):**

6.67

**Maximum Distortion (%):**

-18.51

**Exit Pupil Position (mm):**

-12.23

**Lens Wavelength Range:**

VIS

## Sensor

**Maximum Sensor Format:**

2/3"

**Pixel Size (µm):**

2.74

## Threading & Mounting

**Filter Thread:**

M30.5 x 0.50 (Male)

**Filter Thread Adapter:**

[#89-932 \(Required\)](#)

**Front Thread:**

M22.0 x 0.5 (Male)

**Mount:**

C-Mount

## Environmental & Durability Factors

**Storage Temperature (°C):**  
-20 to +60

**Type of Ruggedization:**  
Industrial (Fixed Aperture with Simplified Mechanics)

## Regulatory Compliance

**RoHS 2015:**  
Compliant

**REACH 201:**  
Compliant

**Certificate of Conformance:**  
[View](#)

## Product Details

- Up to 2/3", C-Mount Lens
- Up to 7.5 MegaPixels, 2.8µm Pixel Size Sensors
- Instrumentation (Ci) Versions of our C Series Lenses with Streamlined Mechanical Designs and Fixed Apertures
- 3.5mm to 50mm Focal Length
- **Ruggedized (Cr) Designs** Also Available

TECHSPEC® Ci Series Fixed Focal Length Lenses are a streamlined version of our C Series Fixed Focal Length Lenses. They feature the same low lens-to-lens variation and broadband anti-reflection (BBAR) coating for maximum light transmission, while offering reduced weight and size. An adjustable, lockable focus allows for setting and locking the best focus position for instrumentation integration. TECHSPEC® Ci Series Fixed Focal Length Lenses are designed specifically for volume integration into applications such as factory inspection and automation to benchtop biomedical devices. The Ci Series offers a wide range of aperture options, ensuring maximum flexibility of resolution, throughput, and depth of field.

Edmund Optics has created a family of high performance optical designs (the C Series family) and developed 6 customized optomechanical solutions targeted for specific applications. These lens sub-families utilize the same optics as the C Series lenses providing the same optical performance in a variety of optomechanical solutions to meet your application requirements:

- **C Series:** Features locking cam focus and iris adjustment and is the most adjustable version of these optical designs; they are the typical high quality machine vision lenses. Also available with a **VIS-NIR Broadband Anti-Reflection (BBAR) Coating**.
- **Ci Series:** Simplified mechanics featuring fixed apertures with compact housing. **Industrial Ruggedization** for reduced size, cost, and locked focus.
- **Cr Series:** All optics glued in place and a locking C-clamp focus ring. **Stabilized Ruggedization** for reduced pixel shift and improved focus stability.
- **Cx Series:** Modular, flexible mechanics allows lenses to be taken apart for easy integration of accessories such as liquid lenses, apertures, and more.
- **Liquid Lens Cx Series:** Designed with an integrated liquid lens for quick autofocus.
- **Cw Series:** Waterproof, designed to meet IEC **Ingress Protection** Code IPX7 and IPX9K.

## Technical Information

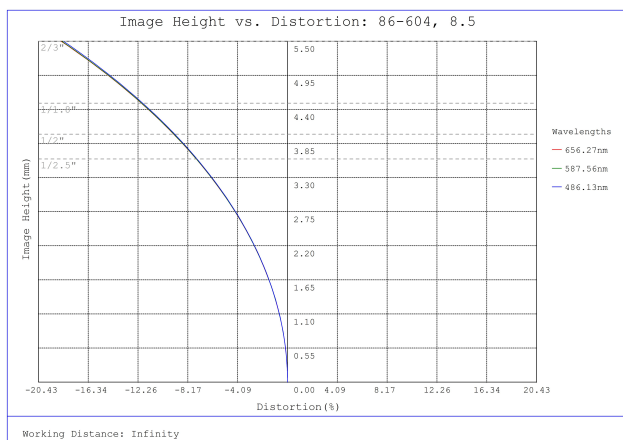

#86-604, 8.5mm, f/8 Ci Series Fixed Focal Length Lens, Distortion Plot

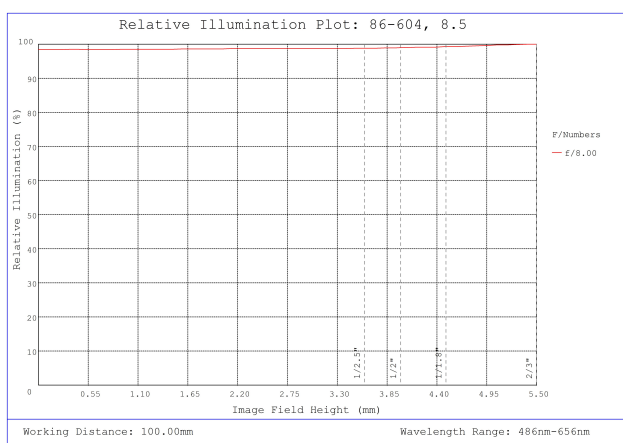

#86-604, 8.5mm, f/8 Ci Series Fixed Focal Length Lens, Relative Illumination Plot

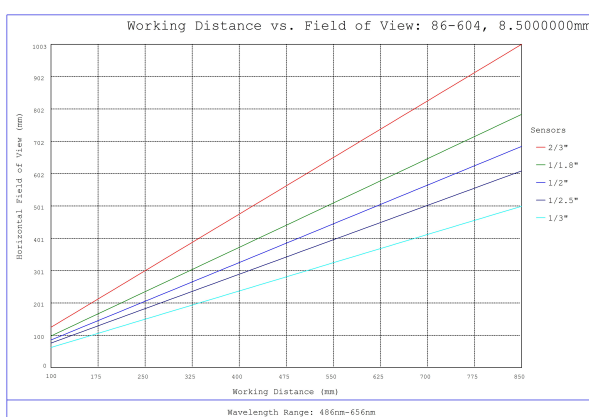

#86-604, 8.5mm, f/8 Ci Series Fixed Focal Length Lens, Working Distance versus Field of View Plot

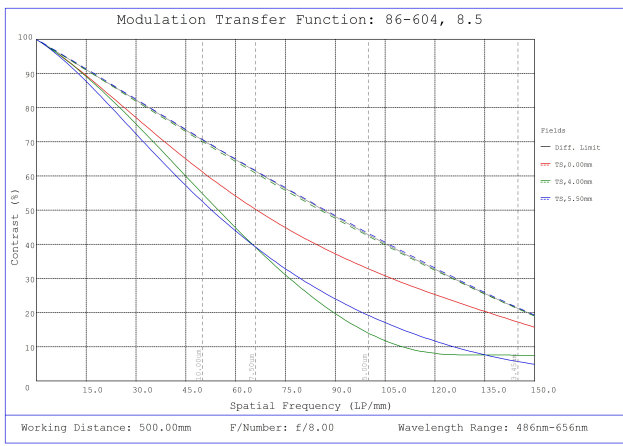

#86-604, 8.5mm, f/8 Ci Series Fixed Focal Length Lens, Modulated Transfer Function (MTF) Plot, 500mm Working Distance, f8

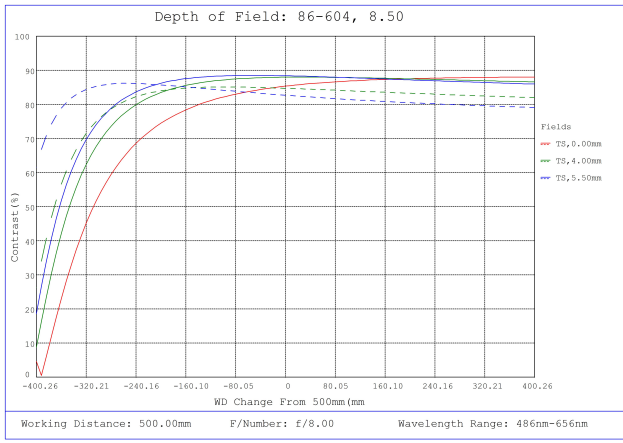

#86-604, 8.5mm, f/8 Ci Series Fixed Focal Length Lens, Depth of Field Plot, 500mm Working Distance, f8

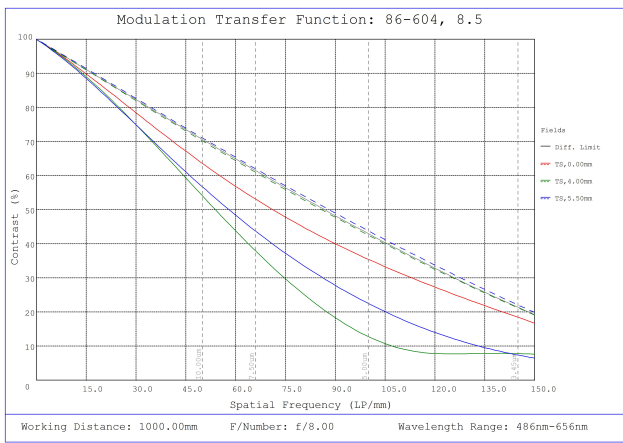

#86-604, 8.5mm, f/8 Ci Series Fixed Focal Length Lens, Modulated Transfer Function (MTF) Plot, 1000mm Working Distance, f8

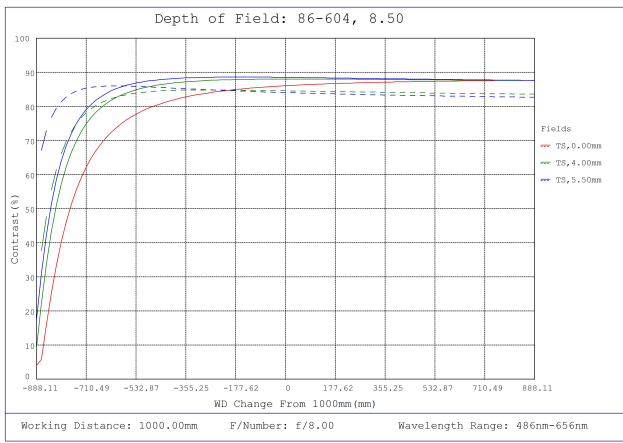

#86-604, 8.5mm, f/8 Ci Series Fixed Focal Length Lens, Depth of Field Plot, 1000mm Working Distance, f8

Focal Length	A	B	C	D
6mm	M34.0 x 0.5	47.8mm	34mm	1.17mm
12mm	M22.0 x 0.75	29.0mm	22mm	0.96mm
16mm	M22.0 x 0.75	40.8mm	22mm	1.09mm
25mm	M22.0 x 0.75	29.9mm	22mm	1.33mm
35mm	M25.5 x 0.5	41mm	22.5mm	3.82mm
50mm	M30.5 x 0.5	49.5mm	30.5mm	2.06mm

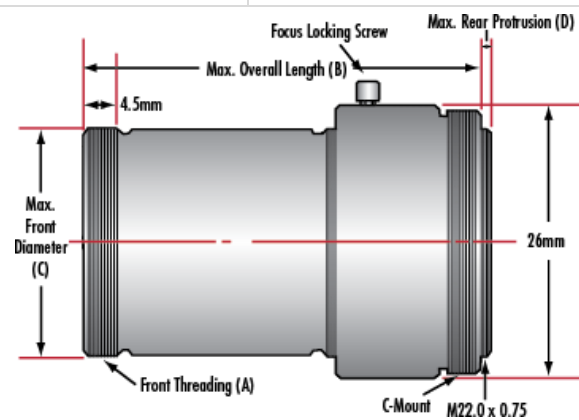

## Compatible Cameras

---