

[See all 5 Products in Family](#)

9mm Dia. x 36mm FL, Commercial Grade, Plano-Convex Lens



Stock #23-073 CLEARANCE **20+ In Stock**

[Other Coating Options](#)

1 A\$31^{.92}

ADD TO CART

Volume Pricing

Qty 1+	A\$31.92 each
Need More?	Request Quote

Product Downloads

General

Plano-Convex Lens **Type:**

Physical & Mechanical Properties

9.00 +0.00/-0.10 **Diameter (mm):**

6.00 **Centering (arcmin):**

1.15 **Edge Thickness ET (mm):**

Clear Aperture CA (mm):
≥7.65

Optical Properties

Effective Focal Length EFL (mm):
36.00

Back Focal Length BFL (mm):
34.89

Coating:
MgF₂ (400-700nm)

Coating Specification:
R_{avg} ≤ 1.75% @ 400 - 700nm

Substrate:
N-BK7

Focal Length Tolerance (%):
±1

Radius R₁ (mm):
18.61

f#:
4.00

Numerical Aperture NA:
0.13

Regulatory Compliance

Certificate of Conformance:
[View](#)

Product Details

- Feature Standard Designs and Specifications
- Also Available [Uncoated](#)
- For More Options, View [Precision Quality Plano-Convex \(PCX\) Lenses](#)

Plano convex lenses (PCX) have one flat and one outward curving face and a positive focal length. They are ideal for collecting and focusing light in imaging applications. They are also useful in a variety of applications involving emitters, detectors, lasers, and fiber optics. MgF₂ anti-reflection coating offers improved transmission in the visible spectrum. Commercial Grade MgF₂ Coated Plano-Convex (PCX) Lenses offer commercial quality, at an affordable price.

Technical Information

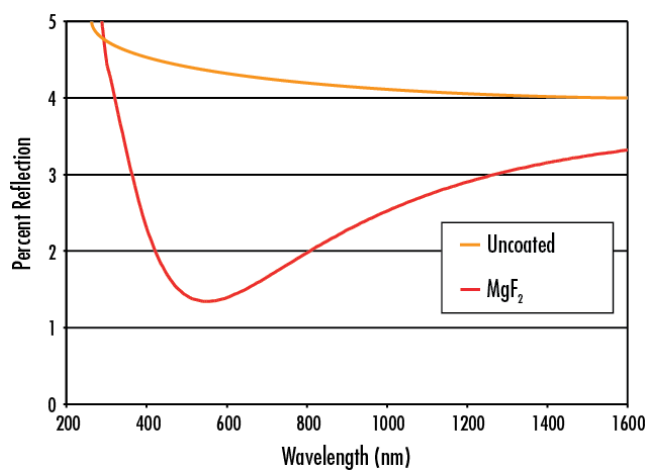
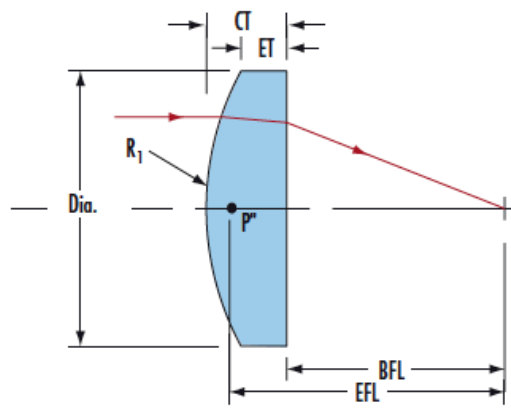

Coating Curves