

TECHSPEC® f/8.0 Aperture for 12mm Cx Lens



Aperture for Cx Lens (representative photo). Aperture varies by stock number. View PDF drawing for additional information.

Stock **#33-628** **1 In Stock**

A\$18⁰⁰

ADD TO CART

Volume Pricing	
Qty 1+	A\$18.40 each
Need More?	Request Quote

Product Downloads

General

Lens Accessory **Type:**

Physical & Mechanical Properties

20.99 **Outer Diameter (mm):**

2.54 **Thickness (mm):**

Optical Properties

Regulatory Compliance

Certificate of Conformance:

[View](#)

Product Details

- Up to 2/3", C-Mount Lens
- Up to 7.5 MegaPixels, 2.8µm Pixel Size Sensors
- Flexible (Cx) Version of our C Series Lenses with Interchangeable Apertures, Filters and Liquid Lens
- 12mm to 50mm Focal Length

TECHSPEC® Cx Series Fixed Focal Length Lenses are designed with simplicity and versatility to easily integrate into a range of application types. The modular 3-piece design allows for flexibility to integrate precision fixed apertures, internal filter holders, or liquid lenses into the assembly. These lenses also feature a simplified focus mechanism with easy to use lock nut and recessed set screws to lock focus position into place. The Cx Series lenses are ideal for applications such as machine vision, [factory automation](#), and research and development. For further documentation information or questions regarding ease of assembly and design support, please review our quick start guides, the lens manual or contact technical support.

These lenses won the Silver Level 2016 Innovators Award and the [2nd place 2017 Inspect Award](#).

Note: One accessory is required for use with the Cx Series lenses. Accessories available include apertures, filter holders, or liquid lens holders. The liquid lens holders are compatible with our [Variable Focus Liquid Lenses](#).

Edmund Optics has created a family of high performance optical designs (the C Series family) and developed 6 customized optomechanical solutions targeted for specific applications. These lens sub-families utilize the same optics as the C Series lenses providing the same optical performance in a variety of optomechanical solutions to meet your application requirements:

- **C Series:** Features locking cam focus and iris adjustment and is the most adjustable version of these optical designs; they are the typical high quality machine vision lenses. Also available with a [VIS-NIR Broadband Anti-Reflection \(BBAR\) Coating](#).
- **Ci Series:** Simplified mechanics featuring fixed apertures with compact housing. [Industrial Ruggedization](#) for reduced size, cost, and locked focus.
- **Cr Series:** All optics glued in place and a locking C-clamp focus ring. [Stabilized Ruggedization](#) for reduced pixel shift and improved focus stability.
- **Cx Series:** Modular, flexible mechanics allows lenses to be taken apart for easy integration of accessories such as liquid lenses, apertures, and more.
- **Liquid Lens Cx Series:** Designed with an integrated liquid lens for quick autofocus.
- **Cw Series:** Waterproof, designed to meet IEC [Ingress Protection](#) Code IPX7 and IPX9K.

Technical Information



Cx Lens Assembly Diagram

	12mm	16mm	25mm	35mm	35mm	50mm
Compatible Liquid Lens	A-25H0	A-25H0	A-25H0	A-25H0	A-39N0	A-39N0
Compatible Liquid Lens Stock No.	#34-282	#34-282	#34-282	#34-282	#34-283	#34-283
Compatible Liquid Lens Development Kit	#34-284	#34-284	#34-284	#34-284	#34-285	#34-285
Liquid Lens Holder Stock No.	#33-631	#33-645	#33-660	#33-675	#33-674	#33-686

Integrating Liquid Lenses into Cx Lenses

Step 1: Choose the focal length of the Cx Lens and the compatible Variable Focus Liquid Lens and Liquid Lens Holder. Or simply choose appropriate Cx Lens Kit, which includes a Cx lens and its compatible Variable Focus Liquid Lens and Liquid Lens Holder.

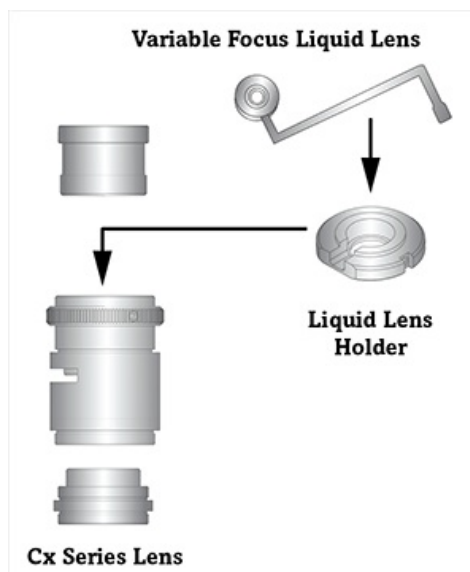

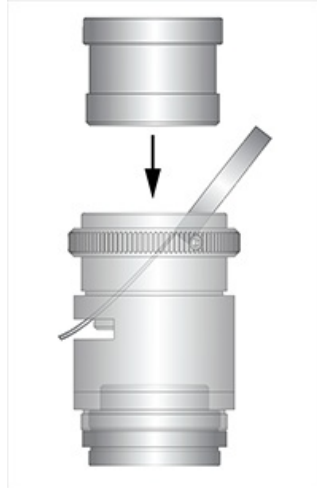

Step 2: Mount the Variable Focus Liquid Lens into the Liquid Lens Holder. Next, assemble both items into the middle of the Cx Lens. [Complete instructions can be found in the downloadable PDF manual.](#)

Step 3, Option 1: Attach Liquid Lens to a [PixeLink USB 3.0 Autofocus Camera](#). This camera provides seamless integration - both driver and autofocus software is included.



Step 3, Option 2: Use with standard C-Mount camera. Driver is not included and a separate Liquid Lens driver must be purchased separately (included in Liquid Lens Development Kit).

