

[See all 14 Products in Family](#)

VZM Ring Light Adapter

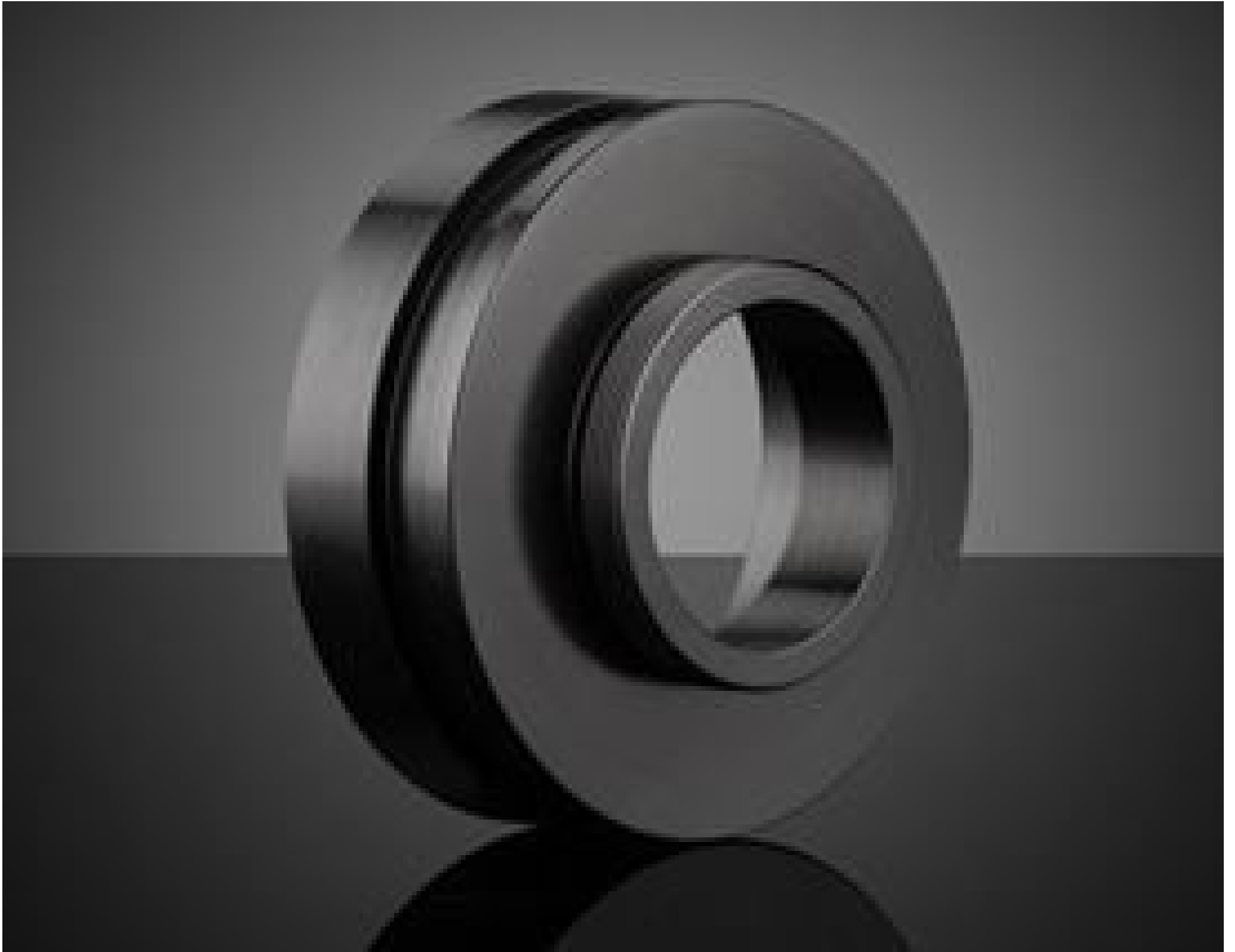

Stock #59-854 **20+ In Stock**

⊖ 1 ⊕ A\$171²⁰

ADD TO CART

Volume Pricing

Qty 1+	A\$171.20 each
Need More?	Request Quote

Product Downloads

General

Note:
Compatible with 200i, 300i, and 450i models

Type:
Lens Accessory

Regulatory Compliance

RoHS 2015:
[Compliant](#)

Certificate of Conformance:
[View](#)

Product Details

- Designed to Accomodate up to 2/3" Sensor Size Formats
- Dependable, Versatile Performance in Compact Designs
- Analog and Digital [Imaging Systems](#) Available

VZM™ Zoom Imaging Lenses enable inspection of a wide range of objects without the inconvenience of changing working distances. In addition, the parfocal zoom allows magnifications to be easily changed without refocusing. These economical lenses are available in working distances ranging from 35mm to 175mm and offer a maximum 2/3" sensor format. Iris versions (i-series) all have locking iris, front filter thread, removable mounting flange, and optional zoom lock. All lenses have a 50mm diameter flange (removable on iris versions except 450i Right Angle) for mounting. VZM™ Zoom Imaging Lenses are ideal for inspection of integrated circuits and solder joints. Also suited for quality control and laboratory inspection needs, as well as surface analysis.

Technical Information

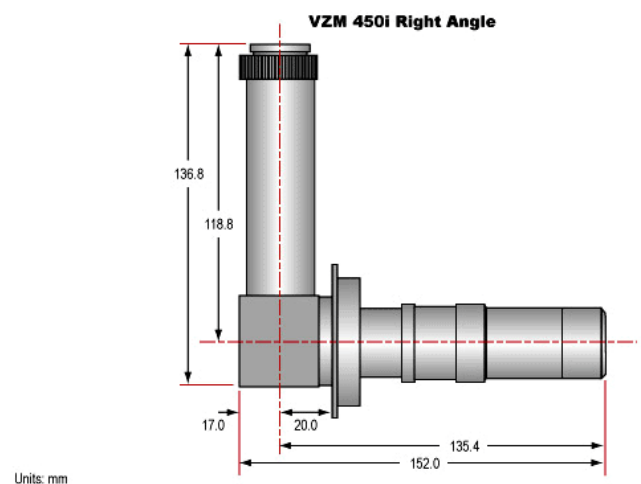
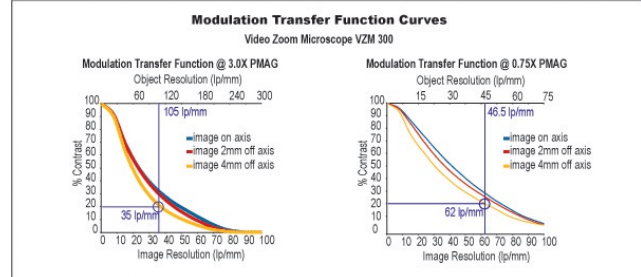
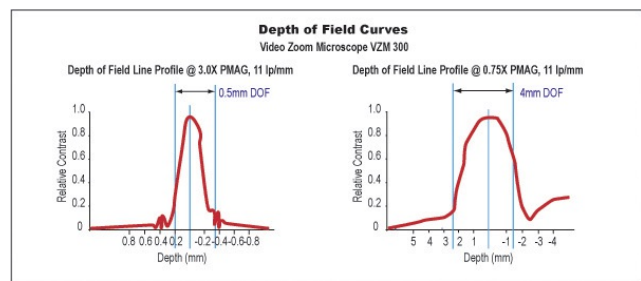
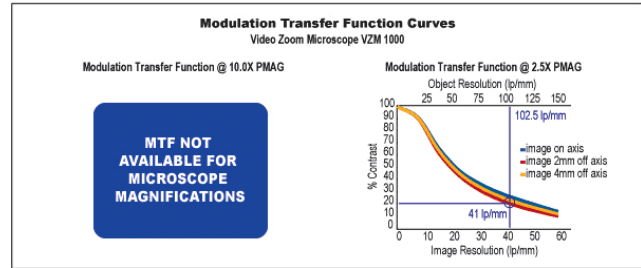
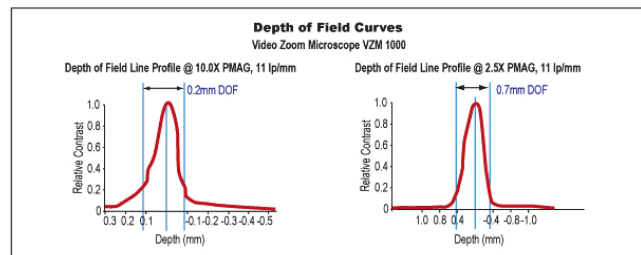
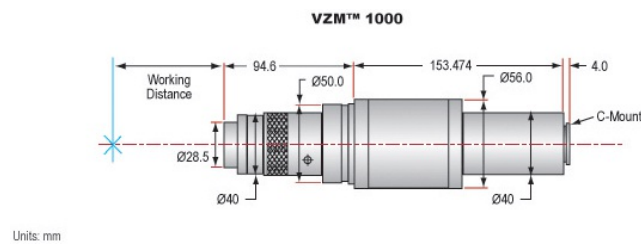
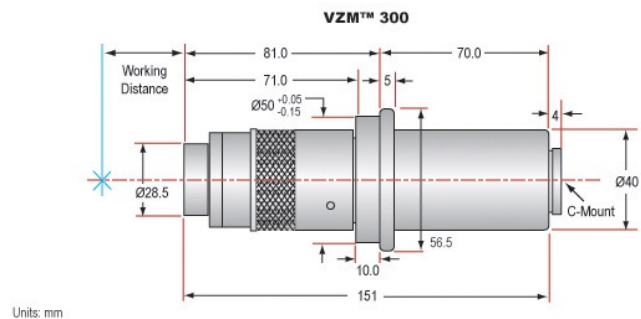

VZM™ 450

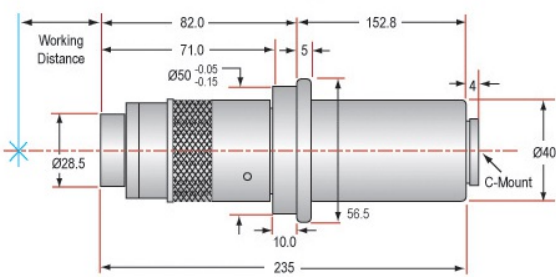

Units: mm

VZM™ 1000i

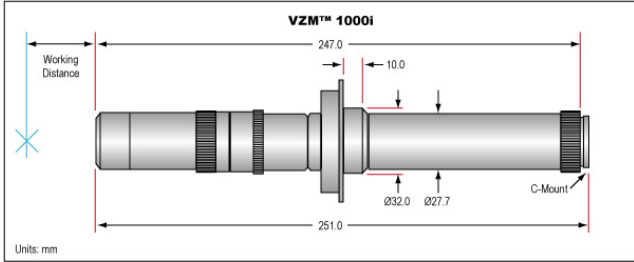

Units: mm

VZM™ 200i

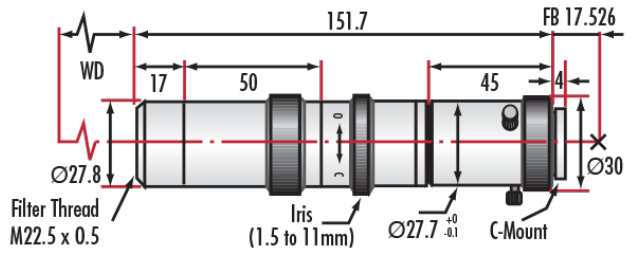

Depth of Field Curves
Video Zoom Microscope VZM 450

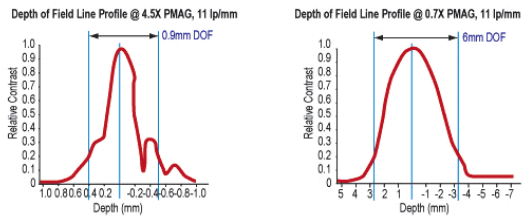

Modulation Transfer Function Curves
Video Zoom Microscope VZM 450

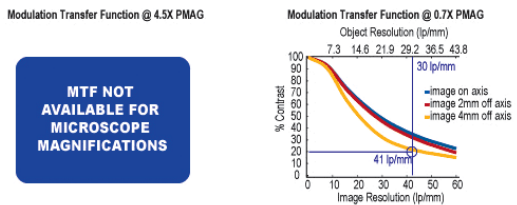

VZM 600i

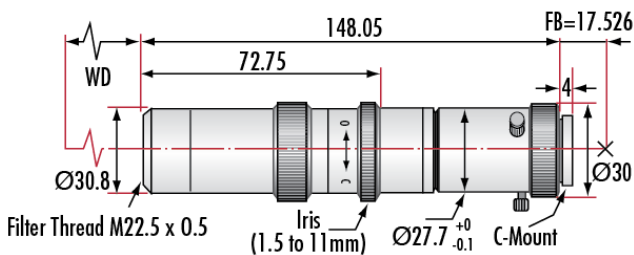

Depth of Field Curves
Video Zoom Microscope VZM 450i

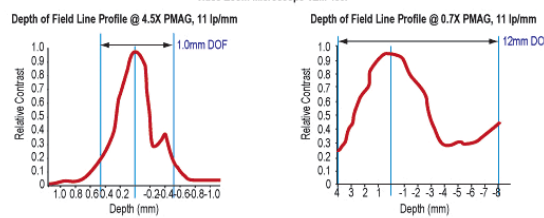

Modulation Transfer Function Curves
Video Zoom Microscope VZM 450i

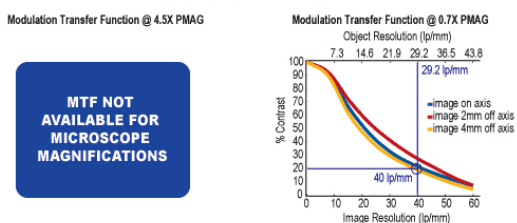

Motorized VZM™ 450

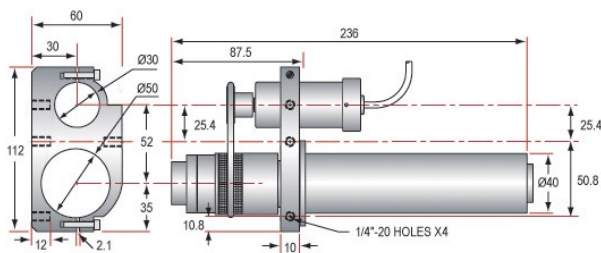

Units: mm

VZM™ 450i

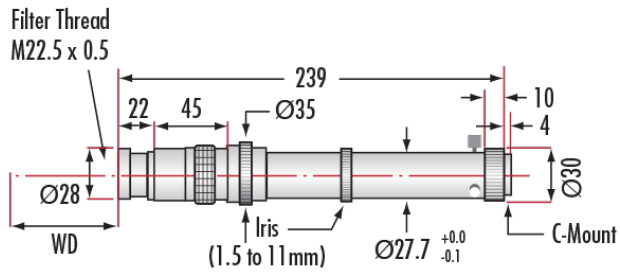

Removable Mounting Flange, i-series (Fits Rack and Pinion #03-609)

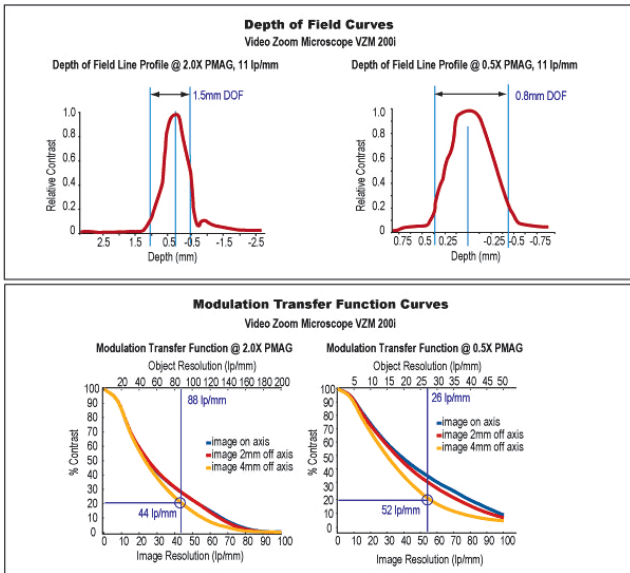
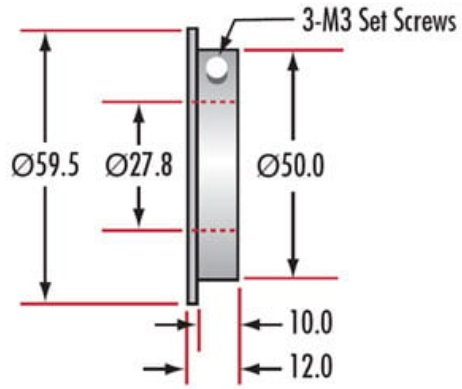

VZM™ 100i

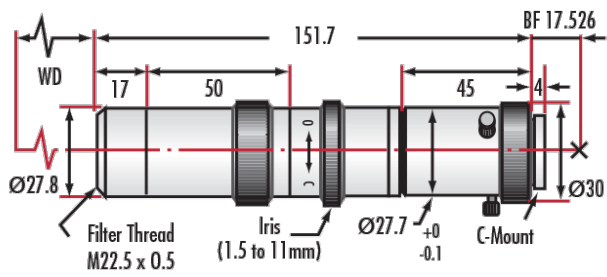

Motorized VZM™ 300

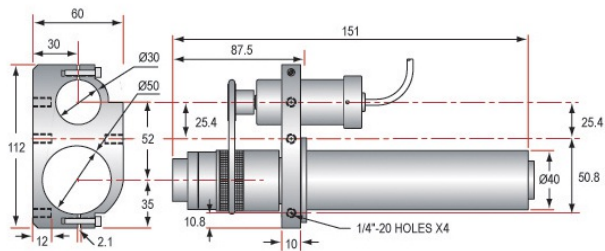

Units: mm

Motorized VZM™ 1000

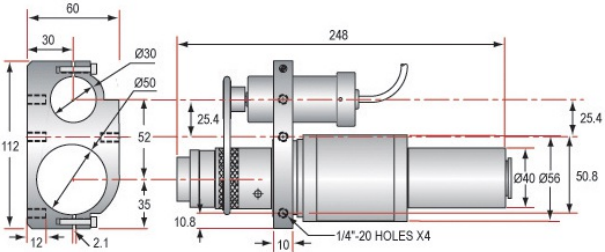

Units: mm

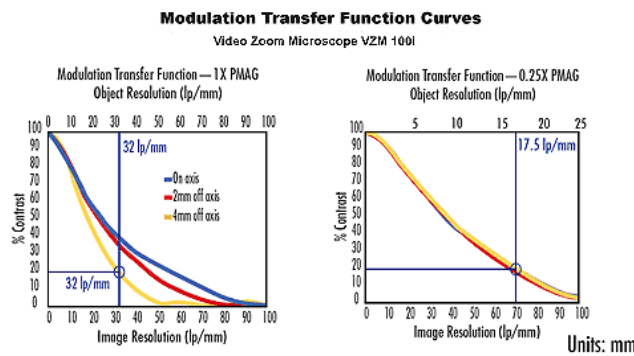
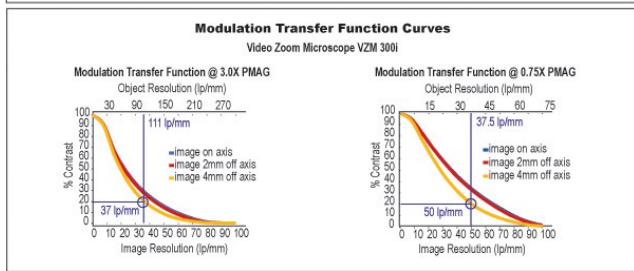
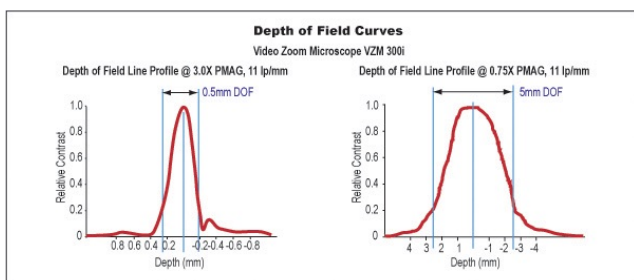

VZM Model	100i	200i	300	300i	450	450i	600i	1000	1000i
Zoom Ratio	4:1	4:1	4:1	4:1	6.4:1	6:1	6:1	4:1	4:1
Magnification	0.25 - 1X	0.5 - 2X	0.75 - 3X	0.75 - 3X	0.7 - 4.5X	0.75 - 4.5X	1 - 6X	2.5 - 10X	2.5 - 10X
Manual Iris	<input type="checkbox"/>	<input type="checkbox"/>		<input type="checkbox"/>		<input type="checkbox"/>	<input type="checkbox"/>		<input type="checkbox"/>
Rotatable Mount	<input type="checkbox"/>	<input type="checkbox"/>		<input type="checkbox"/>		<input type="checkbox"/>	<input type="checkbox"/>		<input type="checkbox"/>
Zoom Lock Adapter	<input type="checkbox"/>	<input type="checkbox"/>		<input type="checkbox"/>		<input type="checkbox"/>	<input type="checkbox"/>		<input type="checkbox"/>
Motorized Version			<input type="checkbox"/>		<input type="checkbox"/>			<input type="checkbox"/>	
Right Angle Version						<input type="checkbox"/>			

Primary Magnification	With 0.5X Lens	
	Minimum 0.25X	Maximum 1.0X
FOV (1/2" Horizontal Sensor)	24.0mm	6.0mm
Resolution in Object Space	10 lp/mm	40 lp/mm
Resolution in Image Space	40 lp/mm	40 lp/mm
Working Distance (±3mm)	152mm	152mm

Primary Magnification	With 0.5X Lens	
	Minimum 0.35X	Maximum 2.25X
FOV (1/2" Horizontal Sensor)	17.6mm	2.8mm
Resolution in Object Space	12 lp/mm	80 lp/mm
Resolution in Image Space	34 lp/mm	35.5 lp/mm
Working Distance (±3mm)	147mm	147mm

Primary Magnification	With 0.5X Lens		With 0.25X Lens	
	Minimum 0.35X	Maximum 2.25X	Minimum 0.175X	Maximum 1.125X
FOV (1/2" Horizontal Sensor)	17.6mm	2.8mm	35.2mm	5.6mm
Resolution in Object Space	12 lp/mm	80 lp/mm	6 lp/mm	40 lp/mm
Resolution in Image Space	34 lp/mm	35.5 lp/mm	34 lp/mm	35.5 lp/mm
Working Distance (±3mm)	147mm	147mm	275mm	275mm